

**ORDNANCE MAINTENANCE**

**Power Train, Body,  
and Frame for  
1/4-Ton 4x4 Truck**

**(Willys-Overland Model MB and Ford Model GPW)**

**Digital Reprint  
CHQSOFTWARE.COM**

WAR DEPARTMENT  
Washington 25, D. C., 8 April 1944

TM 9-1803B, Ordnance Maintenance: Power Train, Body, and Frame for ¼-ton 4 x 4 Truck (Willys-Overland Model MB and Ford Model GPW), is published for the information and guidance of all concerned.

[ A.G. 300.7 (17 Nov 43)  
O.O.M. 461/(TM-9) Rar. Ars. (4-15-44) ]

BY ORDER OF THE SECRETARY OF WAR:

G. C. MARSHALL,  
*Chief of Staff.*

OFFICIAL:

J. A. ULIO,  
*Major General,  
The Adjutant General.*

DISTRIBUTION: R 9 (4); Bn 9 (2); C 9 (5).

(For explanation of symbols, see FM 21-6.)

# CONTENTS

---

	Paragraphs	Pages
CHAPTER 1. INTRODUCTION .....	1- 2	4- 6
CHAPTER 2. POWER TRAIN .....	3-35	7- 98
SECTION I. Power train description .....	3	7
II. Transmission .....	4- 9	7- 24
III. Transfer case .....	10-15	24- 38
IV. Propeller (drive) shafts and uni- versal joints .....	16-21	38- 45
V. Front axle .....	22-28	45- 86
VI. Rear axle .....	29-34	86- 97
VII. Fits and tolerances .....	35	98
CHAPTER 3. BODY AND FRAME .....	36-47	99-136
SECTION I. Springs and shock absorbers .....	36-38	99-110
II. Steering gear and drag link .....	39-40	111-122
III. Body .....	41-42	122-128
IV. Frame .....	43-46	128-136
V. Fits and tolerances .....	47	136
CHAPTER 4. SPECIAL TOOLS .....	48-49	137-139
REFERENCES .....		140-142
INDEX .....		143- 148

---

★This Technical Manual supersedes TB 1803-1, dated 8 December 1943. For supersession of Quartermaster Corps 10-series Technical Manuals, see paragraph 1 j.

# TM 9-1803B

1

## ORDNANCE MAINTENANCE — POWER TRAIN, BODY, AND FRAME FOR ¼-TON 4 x 4 TRUCK (WILLYS-OVERLAND MODEL MB AND FORD MODEL GPW)

### CHAPTER 1

## INTRODUCTION

### 1. SCOPE.

a. The instructions contained in this manual are for the information and guidance of personnel charged with the maintenance and repair of the power train, body, and frame of the ¼-ton 4 x 4 truck. These instructions are supplementary to field and technical manuals prepared for the using arms. This manual does not contain information which is intended primarily for the using arms, since such information is available to ordnance maintenance personnel in 100-series TM's or FM's.

b. This manual contains a description of, and procedure for, removal, disassembly, inspection, and repair of the transmission, transfer case, axles, body, and frame.

c. TM 9-803 contains operating instructions and information for the using arms.

d. TM 9-1803A contains instructions for the information and guidance of personnel charged with the maintenance and repair of the 4-cylinder engine used in these vehicles.

e. TM 9-1825B contains information for the maintenance of the Auto-Lite electrical equipment.

f. TM 9-1826A contains information for the maintenance of the Carter carburetor.

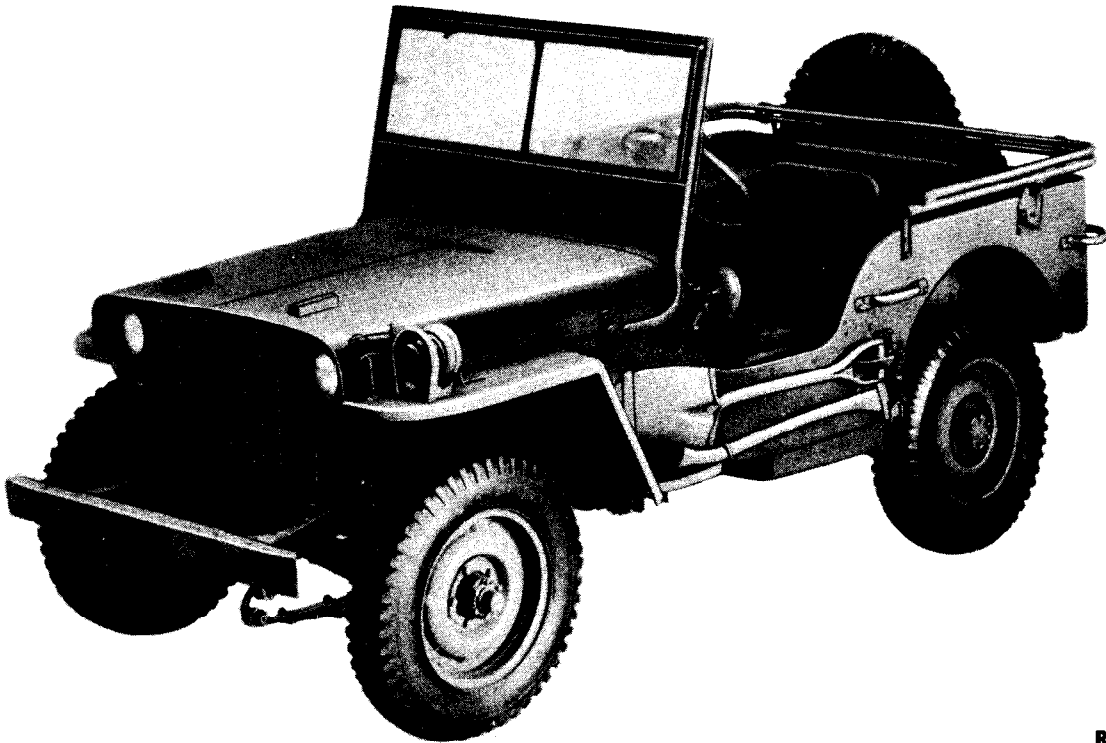
g. TM 9-1827C contains information for the maintenance of the Wagner hydraulic brake system.

h. TM 9-1828A contains information for the maintenance of the A. C. fuel pump.

i. TM 9-1829A contains information for the maintenance of the speedometer.

j. This manual includes pertinent ordnance maintenance instructions from the following Quartermaster Corps 10-series Technical Manuals. Together with TM 9-803 and TM 9-1803A, this manual supersedes them:

- (1) TM 10-1103, dated 20 August 1941.
- (2) TM 10-1207, dated 20 August 1941.
- (3) TM 10-1349, dated 3 January 1942.
- (4) TM 10-1513, Changes 1, dated 15 January 1943.



*Figure 1 — 1/4-ton Truck 4 x 4 — Three-quarter Front View*

RA PD 28742

INTRODUCTION

TM 9-1803B  
1

**ORDNANCE MAINTENANCE — POWER TRAIN, BODY, AND FRAME FOR ¼-TON 4x4 TRUCK  
(WILLYS-OVERLAND MODEL MB AND FORD MODEL GPW)**

**2. MWO AND MAJOR UNIT ASSEMBLY REPLACEMENT RECORD.**

a. **Description.** Every vehicle is supplied with a copy of AGO Form No. 478 which provides a means of keeping a record of MWO's completed or major unit assemblies replaced. This form includes spaces for the vehicle name and U. S. A. Registration Number, instructions for use, and information pertinent to the work accomplished. It is very important that this form be used as directed and that it remain with the vehicle until the vehicle is removed from service.

b. **Instructions for Use.** Personnel performing modifications or major unit assembly replacements must record clearly on the form, a description of the work completed, and must initial the form in the columns provided. When each modification is completed, record the date, hours and/or mileage, and MWO number. When major unit assemblies, such as engine, transmission, transfer case, are replaced, record the date, hours and/or mileage and nomenclature of the unit assembly. Minor repairs and minor parts and accessory replacements need not be recorded.

c. **Early Modifications.** Upon receipt of a vehicle for modification or repair, by a third or fourth echelon repair facility, maintenance personnel will record the MWO numbers of modifications applied prior to the date of AGO Form No. 478.

CHAPTER 2  
POWER TRAIN

---

Section I

POWER TRAIN DESCRIPTION

3. POWER TRAIN DESCRIPTION.

a. The power from the engine is transmitted to the driving wheels through a transmission and a transfer case, each of which provides a means of selecting the gear reduction. The power from the transfer case is transmitted to the front and rear axles through propeller shafts equipped with universal joints. The transmission is located at the rear of the engine and is secured to the clutch housing (fig. 2). The various gears in the transmission (par. 4) are controlled by a shift lever. The transfer case is mounted directly onto the rear of the transmission. The transmission output shaft extends from the rear of the transmission into splines of the main drive gear in the transfer case. The transfer case is provided with two levers, one to select the transfer case ratio, and the other to engage or disengage the front axle (fig. 5). A hand brake drum is mounted on the rear axle output shaft. Each axle is of the spiral bevel hypoid gear full-floating type, equipped with the conventional differential.

---

Section II

TRANSMISSION

4. DESCRIPTION AND DATA.

a. **Description.** The transmission (fig. 3) is of the 3-speed type with synchronized second and high speed gears. The transmission and transfer case are mounted on rubber on the frame center cross-member. The gearshift lever is incorporated in the gearshift housing.

b. **Data.**

Make ..... Warner  
Model ..... T84J  
Type ..... Synchronous Mesh  
Speeds:  
    Forward ..... 3  
    Reverse ..... 1  
Ratios:  
    Low ..... 2.665 to 1  
    Second ..... 1.564 to 1

ORDNANCE MAINTENANCE — POWER TRAIN, BODY, AND FRAME FOR ¼-TON 4x4 TRUCK  
(WILLYS-OVERLAND MODEL MB AND FORD MODEL GPW)

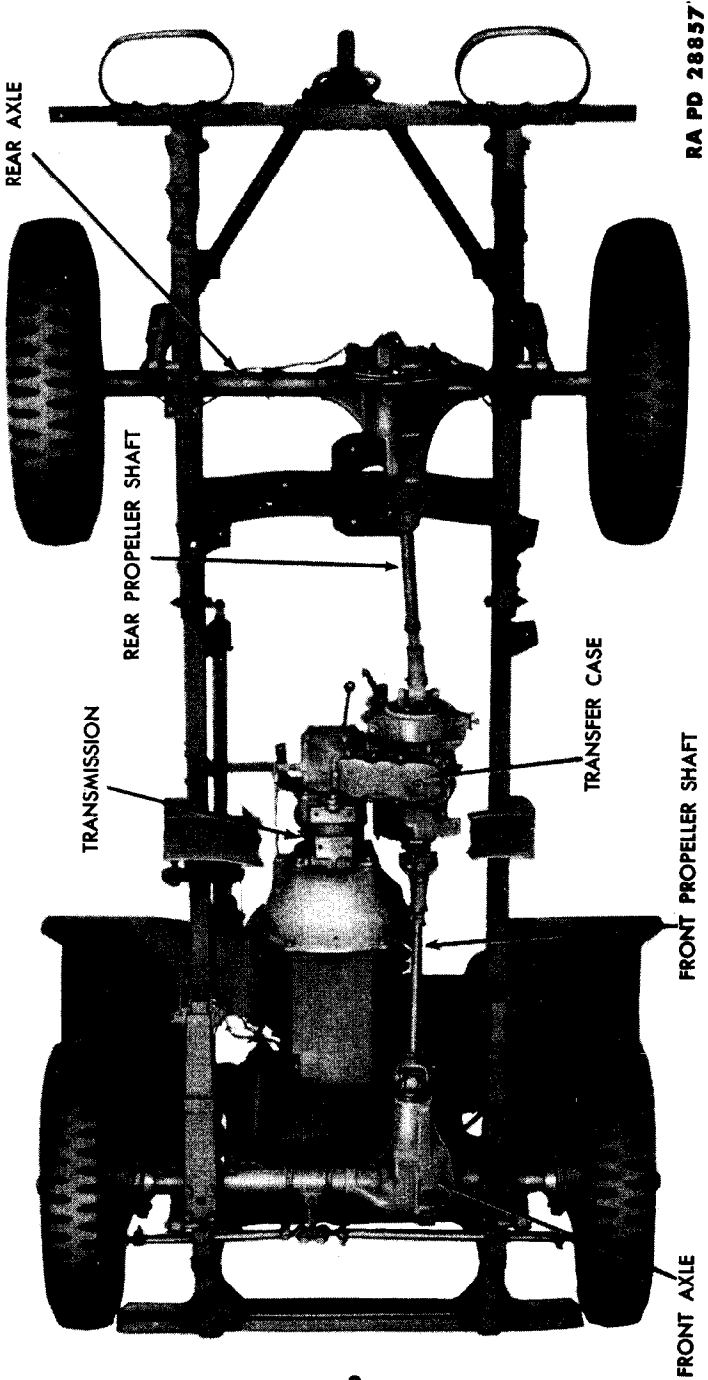


Figure 2 — Power Train

POWER TRAIN

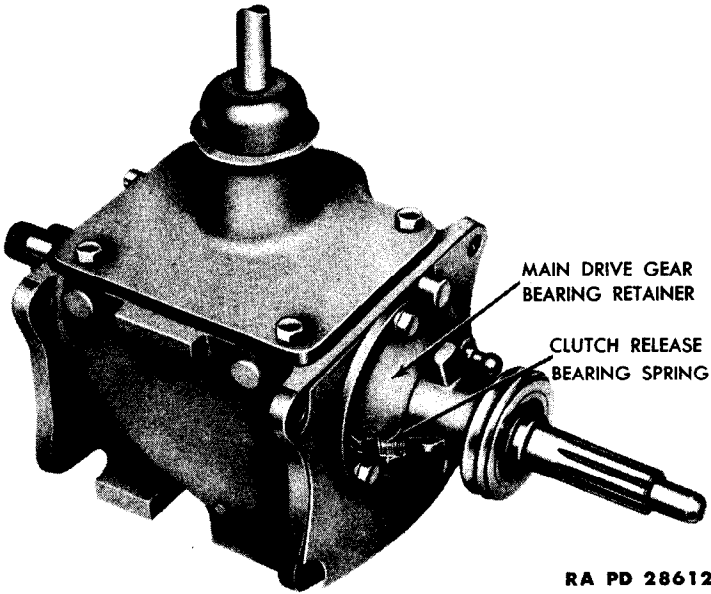
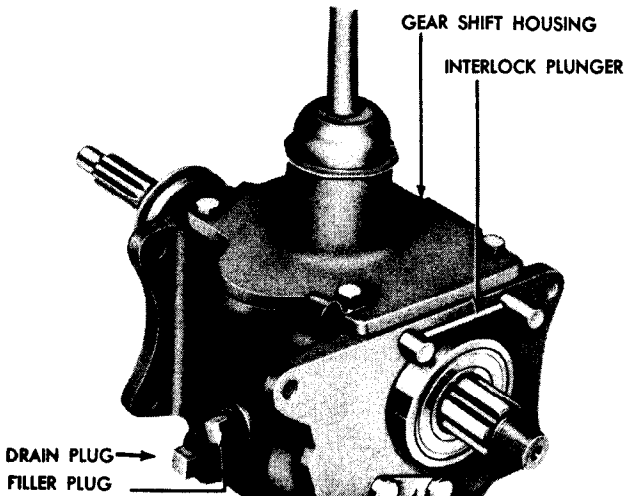
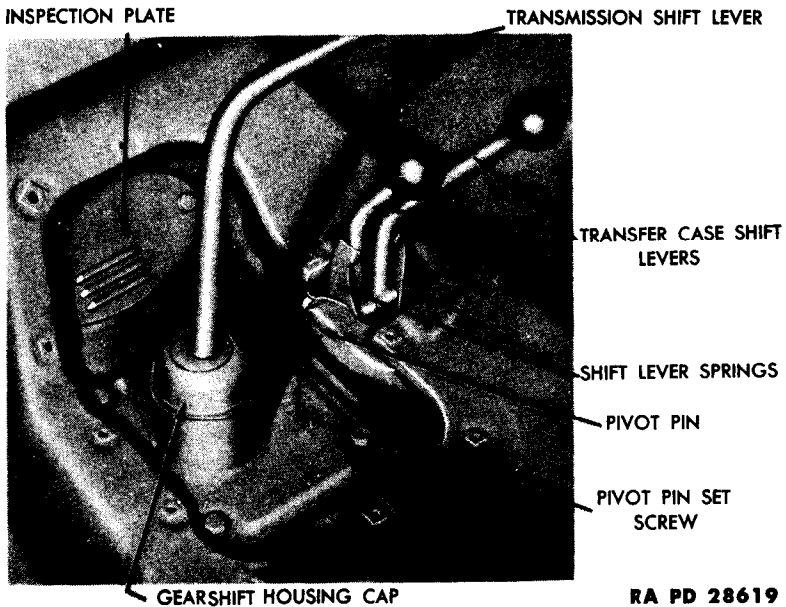


Figure 3 — Transmission — Three-quarter Front View



ORDNANCE MAINTENANCE — POWER TRAIN, BODY, AND FRAME FOR 1/4-TON 4x4 TRUCK  
(WILLYS-OVERLAND MODEL MB AND FORD MODEL GPW)



RA PD 28619

Figure 5 — Transmission and Transfer Case Shift Levers

High .....	1 to 1
Reverse .....	3.554 to 1

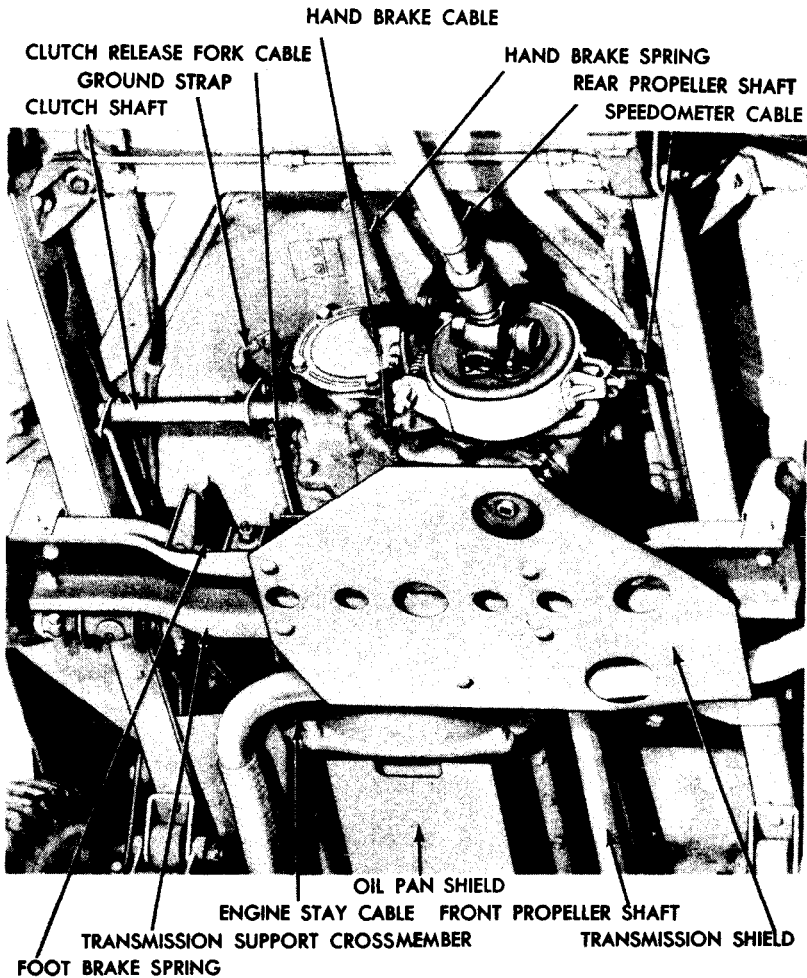
Bearings:

Clutch shaft (flywheel) .....	Bushing
Clutch release .....	Ball
Clutch shaft rear (main drive gear) .....	Ball
Mainshaft front .....	13 rollers
Mainshaft rear .....	Ball
Countershaft gear .....	Bushings (2)
Reverse idle gear .....	Bushing

5. REMOVAL.

a. **Remove Floor Plate and Shift Lever (fig. 5).** Remove the cap screws from the floor plate at the transmission, and remove the floor plate. Remove the gearshift housing cap and remove the shift lever from the transmission. Remove the set screw that secures the shift lever pivot pin on the transfer case and, with a suitable drift, remove the shift lever pivot pin. Remove the two shift levers and shift lever springs from the transfer case. Remove the two cap screws that secure the clutch housing inspection plate and remove the inspection plate.

**POWER TRAIN**



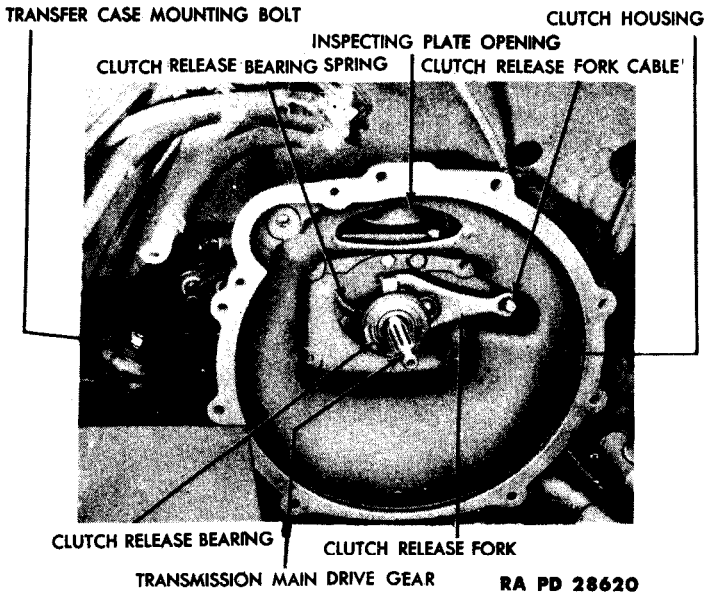
RA PD 28897

**Figure 6 – Under Side of Chassis**

**b. Remove Transmission Shield (fig. 6).** Remove the cap screws that secure the exhaust pipe clamp to the shield, and remove the clamp. Remove the five bolts that secure the transmission shield to the transmission support crossmember. Remove the transmission shield.

**c. Remove Brake Springs and Speedometer Cable (fig. 6).** Remove the hand brake spring. Remove the foot brake spring leading from the bottom of the brake pedal to the transmission support crossmember. Disconnect the speedometer cable at the transfer case.

ORDNANCE MAINTENANCE — POWER TRAIN, BODY, AND FRAME FOR ¼-TON 4x4 TRUCK  
(WILLYS-OVERLAND MODEL MB AND FORD MODEL GPW)



RA PD 28620

**Figure 7 — Clutch Release Fork**

d. **Remove Hand Brake Cable, Clutch Cable, and Engine Stay Cable (fig. 6).** Remove the clevis pin that secures the hand brake cable to the brake band. Remove the hand brake cable clamp at the transfer case. Disconnect the clutch cable at the clutch shaft. Remove the two nuts from the engine stay cable on the transmission support crossmember and remove the engine stay cable.

e. **Remove Propeller Shafts (fig. 6).** Disconnect the front propeller shaft at the transfer case (par. 17 a). Disconnect the rear propeller shaft at the transfer case (par. 17 b).

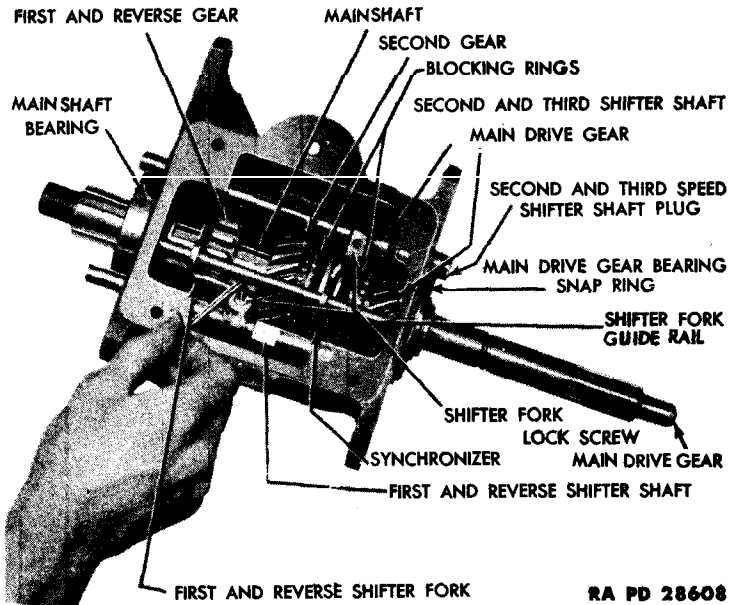
f. **Remove Ground Strap (fig. 6).** Remove the ground strap leading from the transfer case to the floor plate.

g. **Remove Clutch Release Fork (fig. 7).** Working through the inspection plate opening on the clutch housing, remove the clutch cable from the clutch release fork, and remove the clutch release fork from the clutch housing.

h. **Disconnect Radiator Hose.** Drain the coolant from the radiator. Loosen the radiator hose clamp at the radiator end, and remove the hose from the radiator.

i. **Disconnect Transmission at Clutch Housing (fig. 6).** Place a jack under the oil pan shield at the rear of the engine. Remove

**POWER TRAIN**



RA PD 28608

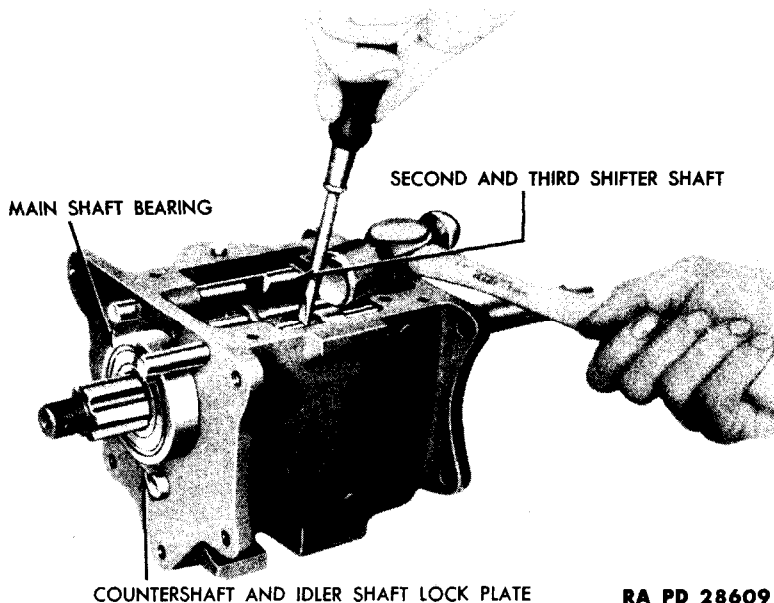
**Figure 8 – Removing Shifter Fork Lock Screws**

three cap screws from each side of the transmission support crossmember. Place another jack under the transmission. Remove the four bolts that secure the transmission to the clutch housing. Lower both jacks evenly until the transmission support crossmember is approximately 2 inches from the frame. Push the transmission and transfer case to the right so as to free the clutch shaft from the ball joint on the transfer case. Pull the transfer case with transmission straight back until the transmission main drive gear is out of the clutch housing and remove the transfer case and transmission.

**j. Remove Transmission Support Crossmember (fig. 6).** Remove the five mounting bolts that secure the transmission and transfer case to the transmission support crossmember. Remove the transmission support crossmember.

**k. Remove Transmission From Transfer Case (fig. 27).** Drain the oil from the transmission and transfer case. Remove the rear cover from the transfer case. Remove the castellated nut and flat washer that secure the drive gear on the transmission mainshaft and remove the drive gear and oil baffle from the transmission mainshaft, using a suitable puller, if necessary. **NOTE: Vehicles of early manufacture were not supplied with this oil baffle.**

**ORDNANCE MAINTENANCE — POWER TRAIN, BODY, AND FRAME FOR ¼-TON 4 x 4 TRUCK  
(WILLYS-OVERLAND MODEL MB AND FORD MODEL GPW)**



**Figure 9 — Removing Shifter Shafts**

**6. DISASSEMBLY.**

a. **Remove Gearshift Housing.** Remove the four cap screws that secure the gearshaft housing to the transmission (fig. 4). Lift the housing, shifter shaft plate, and spring washer from the transmission (fig. 17).

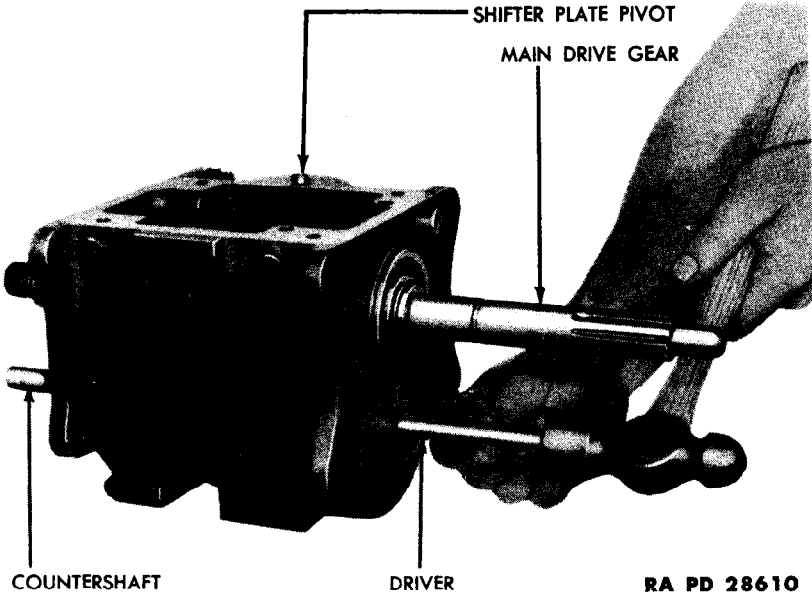
b. **Remove Main Drive Gear Bearing Retainer** (fig. 3). Unhook the clutch release bearing return spring and slide the bearing assembly off the bearing retainer. Remove the three cap screws from the bearing retainer. Slide the bearing retainer and cork gasket off the main drive gear.

c. **Remove Shifter Fork Guide Rail** (fig. 8). Push the shifter fork guide rail out of the transmission.

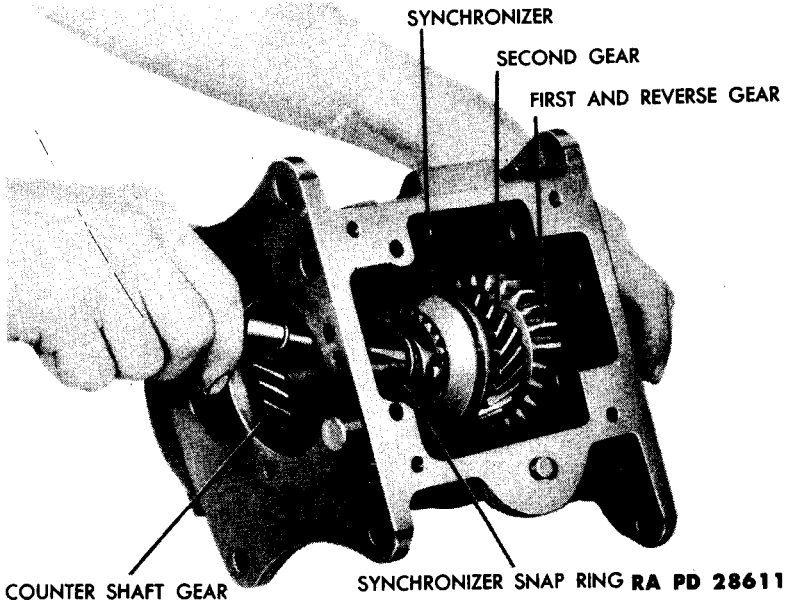
d. **Remove the Low and Reverse, and the Second and High Shifter Forks.** Remove the shifter fork lock screw from each fork (fig. 8). Tap the shifter shafts part way out of the transmission (fig. 9), being careful not to lose the interlocking ball in each shaft. Hold the shifter fork and pull the shafts from the transmission.

e. **Remove Main Drive Gear.** Tap the countershaft and idle reverse shaft lock plate out of the two shafts (fig. 4). With a long

**POWER TRAIN**

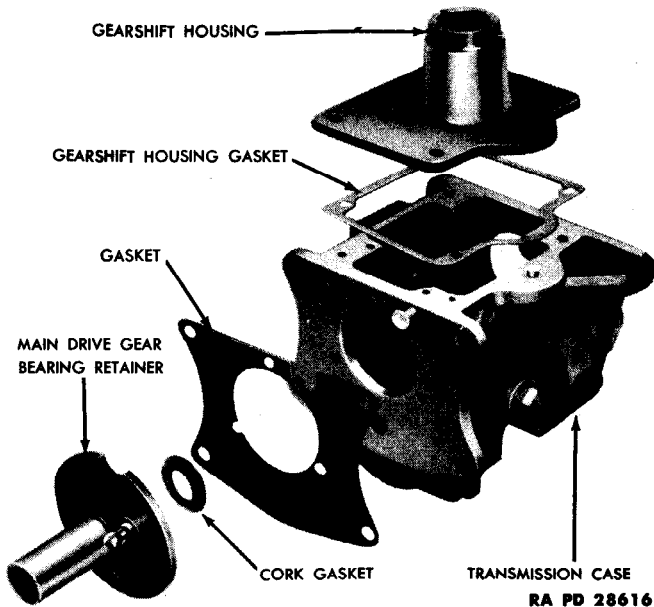


**Figure 10 – Removing Countershaft**



**Figure 11 – Removing Synchronizer Hub Snap Ring**

ORDNANCE MAINTENANCE — POWER TRAIN, BODY, AND FRAME FOR ¼-TON 4x4 TRUCK  
(WILLYS-OVERLAND MODEL MB AND FORD MODEL GPW)



**Figure 12 — Transmission Case and Gearshift Housing — Exploded View**

drift, tap the countershaft out of the transmission (fig. 10). This will allow the countershaft gear to drop to the bottom of the case for clearance to remove the main drive gear. Pull the main drive gear assembly from the transmission.

f. **Remove Mainshaft (fig. 11).** Remove the synchronizer hub snap ring. Slide the synchronizer assembly, second and first and reverse gear off the mainshaft. Remove the shaft.

g. **Remove Idle Reverse Gear.** Tap the idle reverse gear shaft out of the transmission and remove the gear. Lift the countershaft gear and both thrust washers out of the transmission.

h. **Disassemble Countershaft Gear (fig. 14).** Remove the two bushings and spacer from the countershaft gear.

i. **Disassemble Main Drive Gear (fig. 13).** Remove the snap ring and the 13 rollers from the main drive gear.

j. **Disassemble Synchronizer (fig. 13).** Slide the synchronizer sleeve off the synchronizer hub and remove the two lock rings.

## 7. CLEANING, INSPECTION, AND REPAIR.

a. **Cleaning.** Wash all parts thoroughly in dry-cleaning solvent until all trace of old lubricant has been removed. Oil the bearings

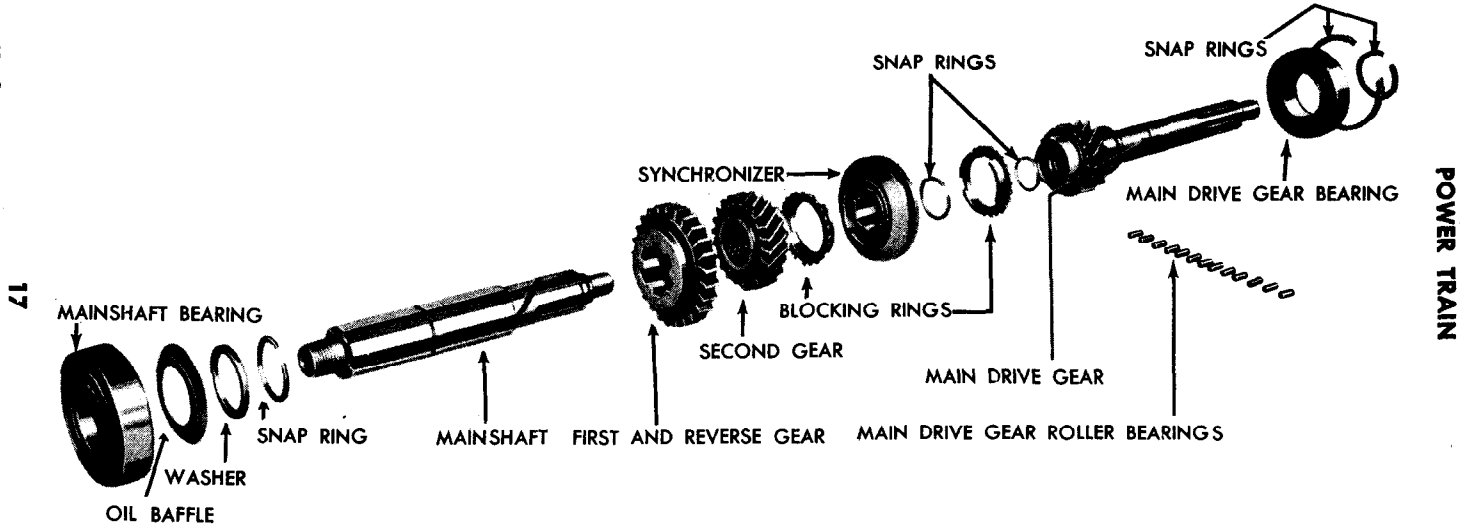


Figure 13 — Mainshaft Assembly — Exploded View

RA PD 28618

**ORDNANCE MAINTENANCE — POWER TRAIN, BODY, AND FRAME FOR ¼-TON 4 x 4 TRUCK  
(WILLYS-OVERLAND MODEL MB AND FORD MODEL GPW)**

immediately after cleaning to prevent corrosion of the highly polished surfaces.

**b. Inspection and Repair.**

(1) **TRANSMISSION CASE ASSEMBLY** (fig. 12). Inspect the case and gearshaft housing for cracks or damage of any kind. Cracked or damaged units must be replaced.

(2) **MAIN DRIVE GEAR ASSEMBLY** (fig. 13). Replace the main drive gear (clutch shaft) if the following conditions are apparent: Broken teeth or excessive wear; pitted or twisted shaft; discolored bearing surfaces due to overheating. Small nicks can be honed and then polished with a fine stone. Measure the roller bearing recess in the gear end of the shaft. If more than 0.974 inch, replace the main drive gear. Measure the pilot end of the shaft. If it is less than 0.595 inch at the pilot end, replace the main drive gear.

(3) **MAINSHAFT** (fig. 13). A mainshaft excessively worn, or with pitted or discolored bearing surfaces due to overheating, must be replaced. Measure the diameter of the pilot end of the shaft and the diameter of the second speed gear bearing surface. If they are less than 0.595 inch at the pilot end, or less than 1.126 inches at the second speed gear bearing surface, replace the mainshaft.

(4) **FIRST AND REVERSE GEAR** (fig. 13). A first and reverse gear with excessively worn teeth or splines, or with broken or chipped teeth must be replaced. Slide the gear onto the mainshaft. If the backlash between the gear and the shaft exceeds 0.005 inch, either the gear or the shaft, or both, must be replaced. A gear with small nicks can be honed and then polished with a fine stone.

**(5) SECOND GEAR** (fig. 13).

(a) *Inspection.* A second gear with excessively worn, broken, or chipped teeth, or scored bearing surface must be replaced. Measure the inside diameter of the gear. If more than 1.129 inches the gear bushing must be replaced (step (b), below). Small nicks can be honed and then polished with a fine stone.

(b) *Second Gear Bushing Replacement.* Place the second gear in an arbor press and, with a suitable driver, press the bushing out of the gear. Use a suitable driver to press a new bushing in the gear. Ream the bushing to from 1.1275 to 1.1280 inches.

(6) **COUNTERSHAFT GEAR** (fig. 14). Replace excessively worn gears, and gears with broken or chipped teeth, or with pitted or discolored bearing surface due to overheating. Measure the front and rear bearing surfaces of the countershaft gear. If more than 0.7625 inch on either end, replace.

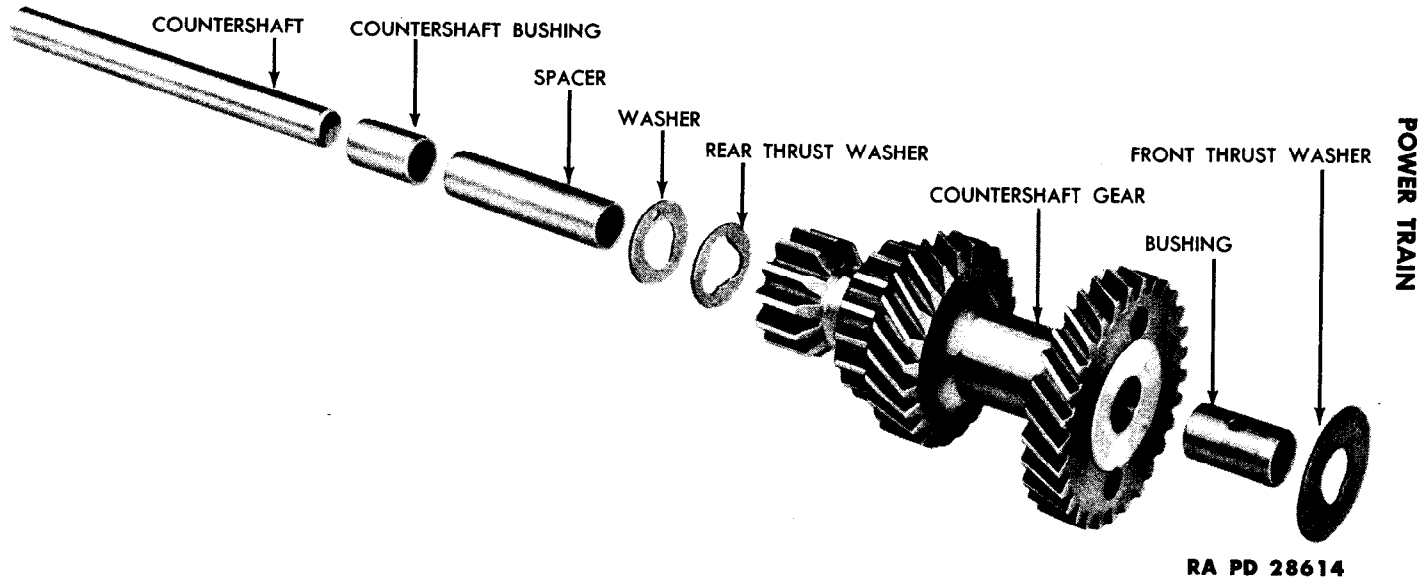


Figure 14 – Countershaft Gear Assembly – Exploded View

ORDNANCE MAINTENANCE — POWER TRAIN, BODY, AND FRAME FOR ¼-TON 4 x 4 TRUCK  
(WILLYS-OVERLAND MODEL MB AND FORD MODEL GPW)

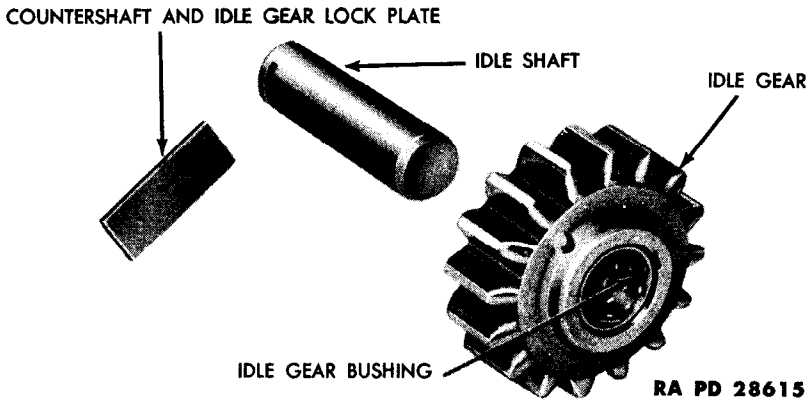


Figure 15 — Idle Gear Assembly — Exploded View

(7) **IDLE GEAR** (fig. 15).

(a) *Inspection.* A gear with excessively worn or broken teeth, or with a scored bearing surface must be replaced. Small nicks can be honed and then polished with a fine stone. Measure the inside diameter of the idle gear bushing. If more than 0.626 inch, the bushing must be replaced (step (b), below).

(b) *Idle Gear Bushing Replacement.* Place the idle gear in an arbor press and, with a suitable driver, press the bushing out of the gear. Use a suitable driver to press a new bushing in the idle gear. Ream the bushing to from 0.623 to 0.624 inch.

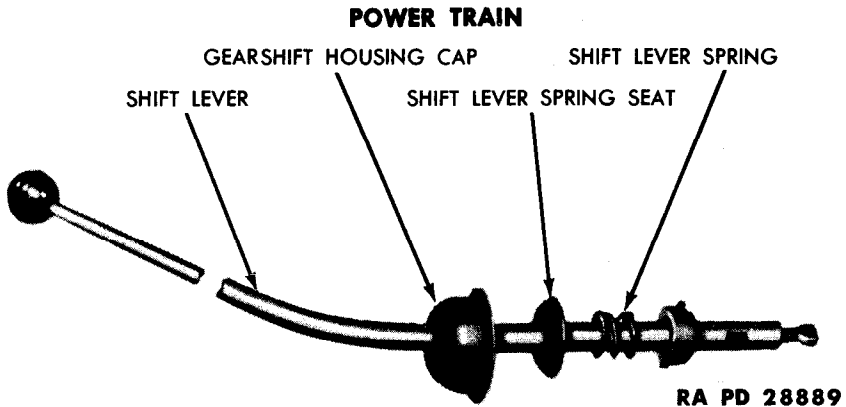
(8) **IDLE GEAR SHAFT AND COUNTERSHAFT** (figs. 14 and 15). Ridged, scored, or excessively worn, shafts must be replaced. An idle gear shaft measuring under 0.6185 inch or countershaft measuring under 0.7490 inch must be replaced.

(9) **SYNCHRONIZER** (fig. 13). Blocking rings with worn, broken, or nicked teeth, must be discarded. Hubs with excessively worn splines must be replaced. Sleeves with broken, nicked, or worn teeth, or excessively worn splines, must be replaced.

(10) **MAIN DRIVE GEAR BEARING ROLLERS** (fig. 13). Needle bearing rollers with flat spots, pitted, or discolored surfaces must be replaced. Measure the diameter of each roller. If less than 0.187 inch, the rollers must be replaced.

(11) **BALL BEARINGS** (fig. 13). Ball bearings with loose or discolored balls, or with pitted or cracked races must be replaced.

(12) **COUNTERSHAFT THRUST WASHERS** (fig. 14). Replace excessively worn or ridged thrust washers. Measure each thrust wash-



**Figure 16 — Transmission Shift Lever**

er. If the front washer is less than 0.029 inch, or if either of the rear washers are less than 0.060 inch, they must be replaced.

(13) **COUNTERSHAFT BUSHINGS** (fig. 14). Excessively worn, scored, or ridged countershaft bushings must be replaced. Measure the inside and outside diameter of the bushings. If the outside diameter is less than 0.759 inch, or if the inside diameter is more than 0.6225 inch, the bushings must be replaced.

(14) **SHIFT LEVER** (fig. 16). Replace the shift lever if it is excessively worn or bent. Check the gearshift housing cap for stripped threads. Replace the shift lever spring, if it is cracked.

### 8. ASSEMBLY.

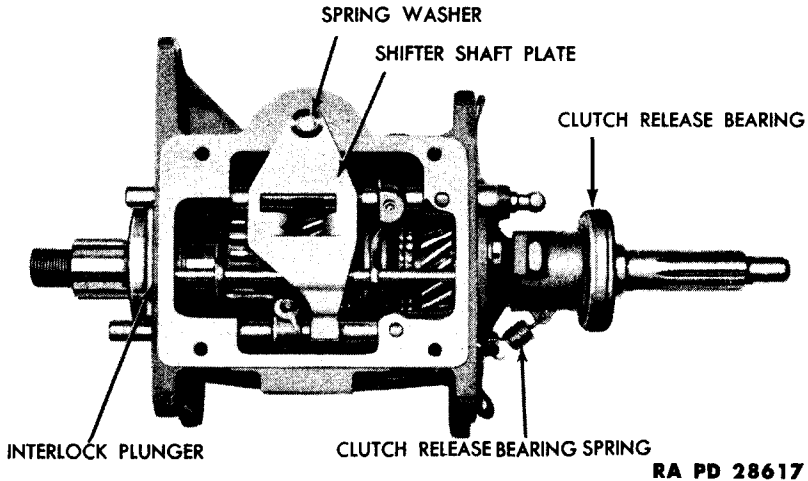
a. **Install Idle Gear.** Hold the idle gear (fig. 15) in place in the case with the cone end of the hub toward the front, and push the idle gear shaft into the case.

b. **Install Countershaft Gear** (fig. 14). Dip the countershaft bearings into SAE 90 oil. Slide the spacer into the countershaft gear and install a bushing in each end of the countershaft gear. Coat the front thrust washer, rear thrust washer, and steel washer with a light film of grease to hold them in place while installing the gear. Lay the countershaft gear in the case with the large gear toward the front.

c. **Install Mainshaft Assembly** (fig. 13). Insert the mainshaft in the case through the opening in the rear of the case. Slide the first and reverse gear onto the shaft, with the shifter fork channel toward the rear. Slide the second gear onto the mainshaft with the tapered end of the gear toward the front. Install a blocking ring onto the second gear. Slide the synchronizer onto the mainshaft with the long end of the hub toward the front and install the snap ring.

d. **Install Main Drive Gear Assembly** (fig. 13). Place the other blocking ring in the synchronizer and install the main drive gear assembly in the case.

ORDNANCE MAINTENANCE — POWER TRAIN, BODY, AND FRAME FOR ¼-TON 4 x 4 TRUCK  
(WILLYS-OVERLAND MODEL MB AND FORD MODEL GPW)



RA PD 28617

**Figure 17 — Gears Installed in Transmission — Top View**

**e. Install Countershaft.** Raise the countershaft gear into position. Making sure the three washers are in line, push the countershaft into the case and tap the lock plate between the countershaft and idle gear shaft (fig. 4).

**f. Install First and Reverse Shifter Fork (fig. 8).** Hold the first and reverse shifter fork in position on the first and reverse gear, and slide the low and reverse shifter shaft (short shaft) into the case about half way. Drop an interlock spring and ball in the pocket. Press down on the ball and push the shifter shaft all the way in the case. Line up the groove of the shaft with the shifter fork and install the lock screw.

**g. Install Second and Third Shifter Fork (fig. 8).** Repeat the same procedure as used in installing the low and reverse shifter fork, and then push the guide rail into the case and through both shifter forks.

**h. Install Gearshift Housing on Case (fig. 17).** Place the transmission in neutral position. Lay the shifter shaft plate on the pivot and on the shifter shafts. Lay the spring washer on the pivot. Place a new gearshift housing gasket on the case. Place the shift lever in neutral position. Lay the housing on the transmission and install the four lock washers and cap screws in the housing.

**i. Install Clutch Release Bearing (fig. 3).** Slide the clutch release bearing assembly onto the main drive gear bearing retainer and install the clutch release bearing return spring.

## POWER TRAIN

### 9. INSTALLATION.

a. **Install Transmission to Transfer Case.** Place the transmission in position on the transfer case. Be sure the interlock plunger (fig. 4) is in position between the two shifter shafts on the transmission. Install the bolts that secure the transmission to the transfer case. Slide the oil baffle and mainshaft gear on the transmission mainshaft through the rear cover opening on the transfer case. (The oil baffle was not supplied on vehicles of early manufacture. If grease is found to have been leaking from the transfer case into the transmission on vehicles without this baffle, reverse the rear mainshaft bearing (fig. 13) so that the open side of the bearing faces the front of the transmission. Leave the oil baffle in front of the bearing in its original position. Install another oil baffle at the rear of the bearing.) Install the flat washer and nut that secure the mainshaft gear to the transmission mainshaft. Install a new gasket and the rear cover on the transfer case (fig. 27).

b. **Place Transmission in Position on Vehicle.** Place a jack under the transmission and raise the transmission and transfer case up until the shaft of the main drive gear is lined up with the splines in the clutch disk.

c. **Install Transmission Main Drive Gear to Clutch Housing.** Insert the shaft of the main drive gear into the clutch splines carefully, do not use force. Slide the transmission in flush with the clutch housing. Install the four bolts that secure the transmission to the clutch housing.

d. **Install Clutch Shaft to Transfer Case** (fig. 6). Push the transfer case to the right until the clutch shaft has enough clearance to enter the ball joint on the transfer case.

e. **Install Transmission Support Crossmember** (fig. 6). Place the transmission support crossmember in position on the transmission. Install the four bolts that secure the crossmember to the transmission. Raise the transmission up with a jack until the crossmember is flush with the frame. With a long nosed drift, line up the holes on the crossmember with the holes in the frame. Install the three nuts and bolts on each end of the crossmember and remove the jack. Install the transfer case mounting bolt.

f. **Install Clutch Release Fork** (fig. 7). Working through the inspection plate opening on the clutch housing, insert the clutch release fork in the clutch housing. Place the release fork behind the clutch release bearing. Slide the clutch release fork cable in the slot on the opposite end of the clutch release fork. Install the clutch release fork cable to the clutch shaft at the transfer case.

**ORDNANCE MAINTENANCE — POWER TRAIN, BODY, AND FRAME FOR ¼-TON 4 x 4 TRUCK  
(WILLYS-OVERLAND MODEL MB AND FORD MODEL GPW)**

**g. Install Hand Brake Cable (fig. 6).** Install the hand brake cable to the brake band at the transfer case. Install the hand brake spring leading from the brake band linkage to the body floor plate. Install the clamp that secures the hand brake cable to the transfer case.

**h. Install Engine Stay Cable and Ground Strap (fig. 6).** Install the engine stay cable leading from the engine rear plate to the transmission support crossmember. Install the ground strap leading from the transmission to the floor plate.

**i. Install Propeller Shafts and Speedometer Cable (fig. 6).** Install the rear propeller shaft to the transfer case (par. 21 a). Install the front propeller shaft to the transfer case (par. 21 b). Install the speedometer cable to the transfer case.

**j. Install Transmission Shield (fig. 6).** Install the five nuts and bolts that secure the shield to the transmission support crossmember. Install the clamp that secures the exhaust pipe to the shield.

**k. Lubricate and Adjust Clutch.** Fill both the transmission and transfer case to proper oil level with specified oil. Adjust the clutch pedal free travel (refer to TM 9-803).

---

**Section III**

**TRANSFER CASE**

**10. DESCRIPTION AND DATA.**

**a. Description.** The transfer case (figs. 28 and 29) is located at the rear of the transmission. The transfer case is essentially a 2-speed transmission, which provides two gear ratios and a means of distributing the power from the transmission to the two axles.

**b. Data.**

<b>Make</b> .....	Spicer
<b>Model</b> .....	18
<b>Mounting</b> .....	Unit with transmission
<b>Shift lever</b> .....	Floor
<b>Ratio:</b>	
<b>High</b> .....	1 to 1
<b>Low</b> .....	1.97 to 1

**POWER TRAIN**

**Bearings:**

Transmission mainshaft .....	Ball
Idle gear .....	2 rollers
Output shaft .....	Taper rollers
Front axle clutch shaft front bearing.....	Ball
Rear pilot in output shaft.....	Bronze bushing

**11. REMOVAL.**

a. **Remove Transmission Shield (fig. 6).** Remove the two cap screws that secure the exhaust pipe clamp to the shield. Remove the exhaust pipe clamp. Remove the five bolts that secure the transmission shield to the transmission support crossmember and remove the shield.

b. **Remove Hand Brake Cable and Clutch Cable (fig. 6).** Remove the hand brake spring at the transfer case. Remove the clevis pin that secures the hand brake cable at the brake on the transfer case. Remove the hand brake cable clamp on the transmission. Remove the clevis pin from the clutch cable at the transmission support crossmember.

c. **Remove Mounting Bolt and Rear Cover (figs. 7 and 27).** Remove the mounting bolt that secures the transfer case to the transmission support crossmember at the right side of the transfer case. Remove the five cap screws that secure the rear cover to the transfer case.

d. **Remove Rear Propeller Shaft (fig. 7).** Disconnect the rear propeller shaft at the transfer case (par. 17 b).

e. **Remove Mainshaft Gear (fig. 27).** Through the opening at the rear of the transfer case, remove the castellated nut that secures the mainshaft gear to the transmission mainshaft. Remove the flat washer mainshaft gear and oil retainer.

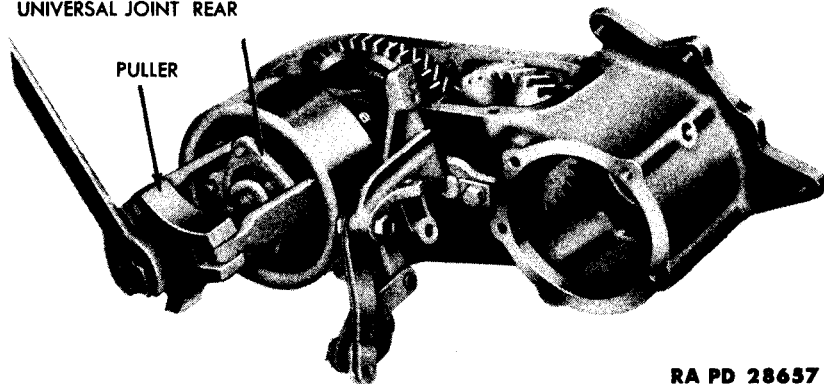
f. **Remove Transfer Case.** Place a jack under the transfer case. Remove the five cap screws that secure the transfer case to the transmission. Move the transfer case straight back until the transmission mainshaft is out of the transfer case. Remove the transfer case.

**12. DISASSEMBLY.**

a. **Remove Brake Band and Drum Assembly (fig. 28).** Remove the two anchor screws from the brake band. Remove the brake band adjusting nut and adjusting screw. Remove the clevis pin from the hand brake linkage. Remove the brake band assembly. Remove the castellated nut that secures the universal joint flange to the output shaft. Install puller 41-P-2912 on the universal joint flange and remove the flange and brake drum (fig. 18). *NOTE: The puller illustrated in figure 18 is similar to puller 41-P-2912.*

**ORDNANCE MAINTENANCE — POWER TRAIN, BODY, AND FRAME FOR ¼-TON 4x4 TRUCK  
(WILLYS-OVERLAND MODEL MB AND FORD MODEL GPW)**

UNIVERSAL JOINT REAR



RA PD 28657

**Figure 18 — Removing Rear Universal Joint Flange  
With Puller Similar to Puller 41-P-2912**

**b. Remove Rear Output Shaft Bearing Cap (fig. 26).** Remove the four cap screws that secure the rear output shaft bearing cap to the transfer case housing. Remove the rear output shaft bearing cap. Remove the rear bearing cap shims. Remove the speedometer drive gear from the output shaft.

**c. Remove Intermediate Gear and Bottom Cover (figs. 25 and 27).** Remove the 10 cap screws that secure the bottom cover to the transfer case and remove the bottom cover. Remove the cap screw that secures the lock plate. Remove the lock plate. With a suitable driver, remove the intermediate gear shaft. Remove the intermediate gear, thrust washers, and roller bearings through the bottom of the transfer case.

**d. Remove Shifter Shaft and Front Output Shaft Bearing (fig. 29).** Shift front axle drive to the engaged position. Remove the poppet plug, spring, and ball on both sides of the output shaft bearing cap. Remove the five cap screws that secure the front output shaft bearing cap to the transfer case. Remove the front output shaft bearing cap as an assembly with the universal joint flange, clutch shaft, bearing, clutch gear, shifter fork, and shifter rod. Be careful not to lose the interlock in the front bearing cap.

**e. Remove Output Shaft (fig. 19).** Insert a screwdriver between the snap ring and output shaft bearing and pry the output shaft bearing away from the snap ring. Remove the snap ring from the groove in the output shaft. Pull the output shaft out from the rear of the housing. The output shaft bearing, snap ring thrust washer, output shaft sliding gear, and output shaft gear can now be removed through the bottom of the transfer case.

POWER TRAIN

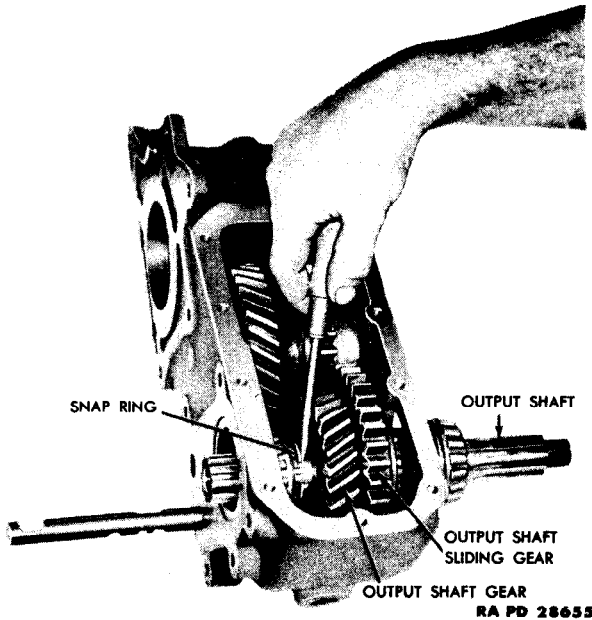


Figure 19 — Removing Snap Ring From Output Shaft

f. **Disassemble Front Output Shaft Bearing Cap** (fig. 21). Remove the set screw that secures the shifter fork to the front wheel drive shifter shaft. Slide the shifter shaft out of the shifter fork. Remove the shifter fork and clutch gear from the bearing cap. Remove the snap ring that secures the output shaft bearing and remove the output shaft bearing from the bearing cap.

**13. CLEANING, INSPECTION, AND REPAIR.**

a. **Cleaning.** Cleaning all parts thoroughly in dry-cleaning solvent. Clean the bearings by rotating them while immersed in dry-cleaning solvent until all trace of lubricant has been removed. Oil the bearings immediately to prevent corrosion of the highly polished surface.

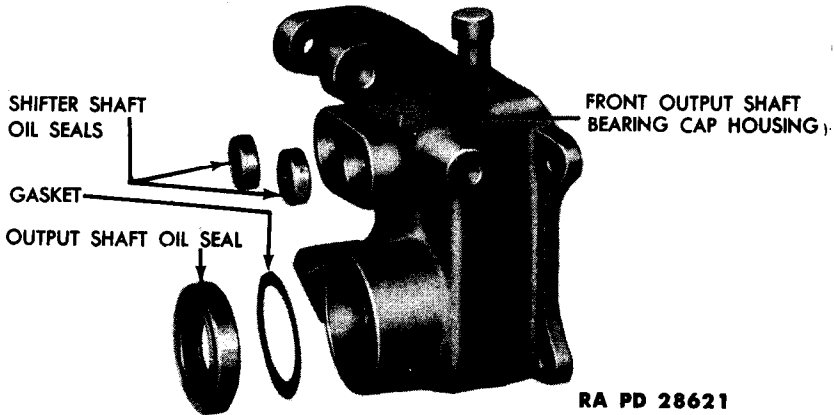
**b. Inspection.**

(1) **TRANSFER CASE ASSEMBLY** (fig. 27). Inspect the transfer case housing for cracks or damage of any kind. Inspect the bottom and rear cover for bent or damaged condition. Replace the gaskets on the bottom and rear covers.

(2) **FRONT OUTPUT SHAFT BEARING CAP ASSEMBLY** (fig. 21).

(a) **Front Output Shaft Bearing Cap Housing** (fig. 20). Replace the front bearing cap, if it is cracked or damaged. Shifter shaft and output shaft oil seals must be replaced (subpar. c, below).

ORDNANCE MAINTENANCE — POWER TRAIN, BODY, AND FRAME FOR ¼-TON 4 x 4 TRUCK  
(WILLYS-OVERLAND MODEL MB AND FORD MODEL GPW)



RA PD 28621

Figure 20 — Front Output Shaft Bearing Cap Housing and Oil Seals

(b) *Front Wheel Drive Shifter Shaft and Fork* (fig. 21). Replace the front wheel drive shifter shaft, if bent or damaged. Replace the fork if it has stripped set screw threads, if it is cracked or has bent forks.

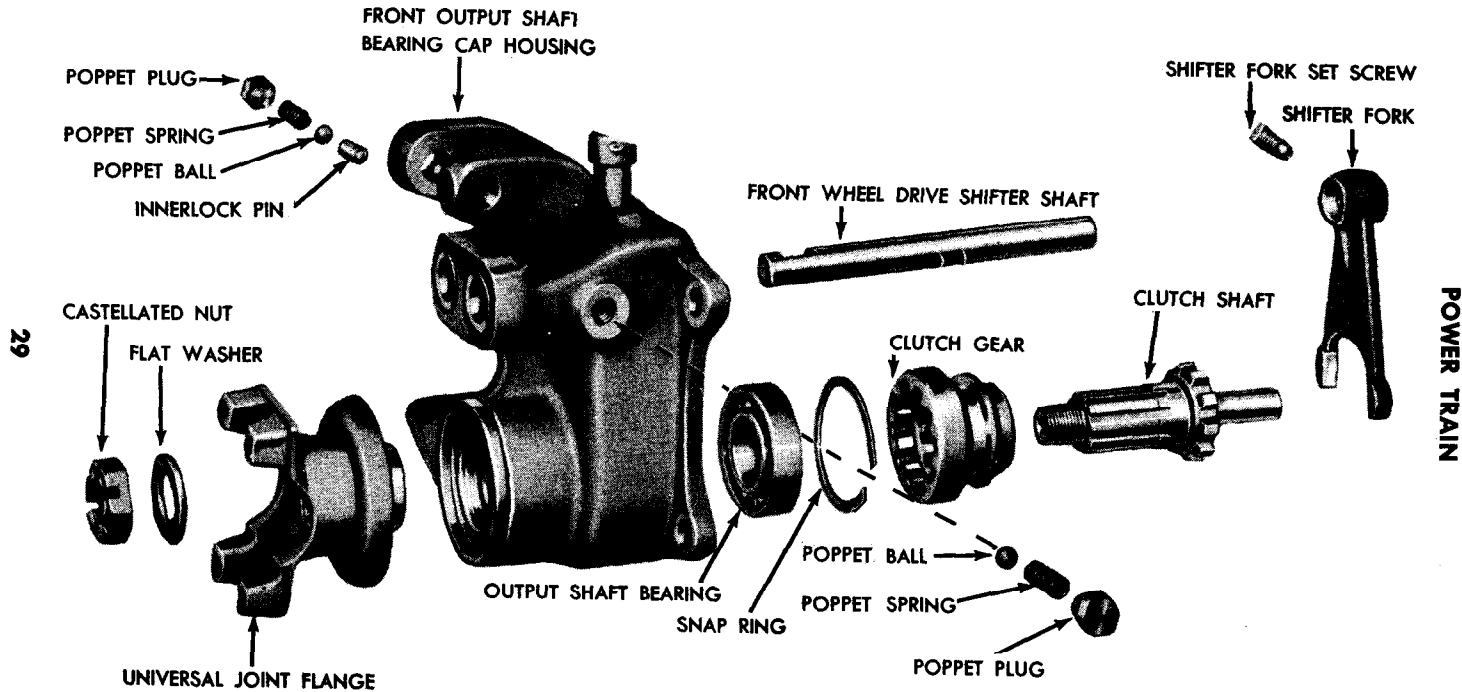
(c) *Clutch Shaft and Gear* (fig. 21). Replace the clutch shaft if the splines or gear teeth are chipped or worn, if the gear has any teeth missing. Check the diameter of the pilot end of the clutch shaft. If the diameter is less than 0.625 inch, replace the clutch shaft. Replace the clutch gear, if it is worn or has any broken teeth.

(d) *Output Shaft Bearing* (fig. 21). Ball bearings with loose or discolored balls or with pitted or cracked races must be replaced.

(3) **INTERMEDIATE GEAR ASSEMBLY** (fig. 25). Replace the intermediate gear if excessively worn, or if any teeth are damaged. Check the thickness of the thrust washers. If the thrust washers are less than 0.093 inch in thickness, replace them. Check the diameter of the intermediate gear shaft. If the diameter is less than 0.750 inch, replace the intermediate gear shaft. Replace the roller bearing, if the rollers are scored or have flat spots.

(4) **REAR OUTPUT SHAFT BEARING CAP ASSEMBLY** (fig. 26). Replace the output shaft bearing cap if cracked or damaged. Replace the speedometer drive gear if it is worn or has damaged teeth. Replace the oil seal in the output shaft bearing cap housing (subpar. c, below). Replace the brake drum if it is worn or bent. Replace the universal joint rear flange, if the splines are worn. Replace the dust shield on the flange if bent.

(5) **OUTPUT SHAFT ASSEMBLY** (fig. 24). Replace the output shaft if the splines are worn. Small nicks can be removed by honing and then polishing with a fine stone. Measure the inside diameter of

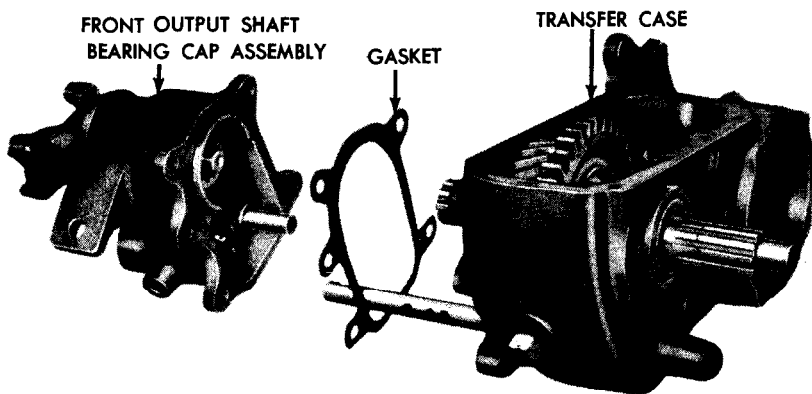


29

Figure 21 — Front Output Shaft Bearing Cap — Exploded View

RA PD 28625

**ORDNANCE MAINTENANCE — POWER TRAIN, BODY, AND FRAME FOR ¼-TON 4x4 TRUCK  
(WILLYS-OVERLAND MODEL MB AND FORD MODEL 6PW)**



**RA PD 28623**

**Figure 22 — Installing Front Output Shaft Bearing Cap to Transfer Case**

the bushing in the output shaft. If it is greater than 0.627 inch, replace the output shaft. Replace the output shaft gear if it is worn or has any damaged teeth. Replace the sliding gear, if it is worn or has damaged teeth. Measure the thickness of the thrust washer. If the thrust washer thickness is less than 0.103 inch, replace it. Replace the roller bearings if they are scored or have flat spots, or if the races are nicked or cracked.

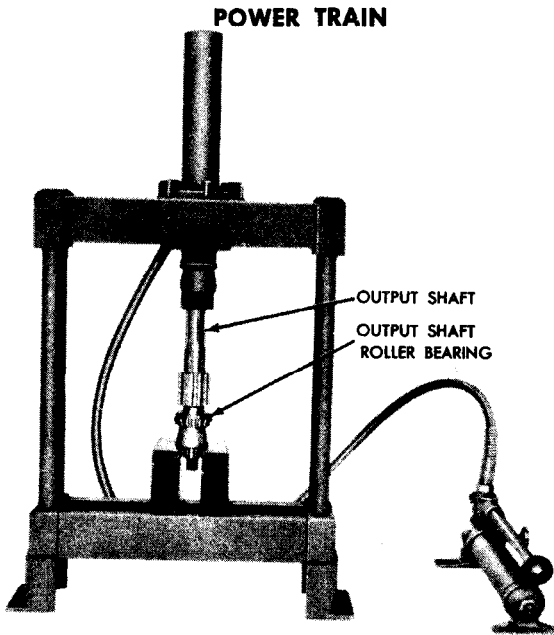
(6) **UNDER DRIVE SHIFTER FORK ASSEMBLY** (fig. 24). Check the fork for stripped set screw threads, cracked or bent forks. Replace if in any of these conditions. Replace the under drive shifter shaft if it is bent.

(7) **SHIFT LEVER ASSEMBLY** (fig. 29). Replace the shift levers if found bent or damaged. Replace the shift lever spring if bent or cracked. Measure the diameter of the shift lever pivot pin. If the diameter is less than 0.500 inch, replace the pivot pin.

c. **Output Shaft Bearing Cap Oil Seal Replacement** (fig. 20). Drive the old oil seal out of the output shaft bearing cap housing, using a suitable driver. Drive the oil seals out, working from the inside of the cap housing. To install a new oil seal, use a driver the size of the oil seal and drive the new seal in the output shaft bearing cap housing.

#### **14. ASSEMBLY.**

a. **Assemble the Front Output Shaft Bearing Cap** (fig. 21). Insert the bearing in the output shaft bearing cap. Install the snap ring that secures the bearing in the output shaft bearing cap. Insert the clutch shaft through the bearing from the inside of the output shaft bearing cap. Insert the front wheel drive shifter shaft in the output



**Figure 23 — Pressing Output Shaft Bearing on Output Shaft**

shaft bearing cap through the outer side of the output shaft bearing cap. Place the front wheel drive shifter fork in position on the clutch gear. Slide the shifter fork on the shifter shaft and clutch gear on the clutch shaft together. Install the set screw in the shift fork and secure with a lock wire. Install the universal joint flange on the clutch shaft. Install the washer and castellated nut that secure the universal joint flange to the clutch shaft.

**b. Install Under Drive Shifter Fork (fig. 20).** Place the under drive shifter fork in the transfer case housing. Insert the under drive shifter shaft in the transfer case and shifter fork. Install the shifter fork set screw that secures the fork to the shifter shaft. Secure the set screw with lock wire.

**c. Install Output Shaft in Transfer Case (figs. 23 and 24).** Press the rear output shaft bearing on the output shaft (fig. 23). Set the output shaft sliding gear in the transfer case with the shifter fork in the channel of the sliding gear. Place the output shaft gear in the transfer case with the shoulder of the output shaft gear facing the sliding gear. Insert the output shaft in the transfer case and through the gears. Slide the thrust washer on the output shaft. Install the snap ring that secures the output shaft gear on the shaft. Slide the front output shaft roller bearing on the output shaft and, using a suitable driver, tap the roller bearing snug against the snap ring. Tap the front roller bearing cup

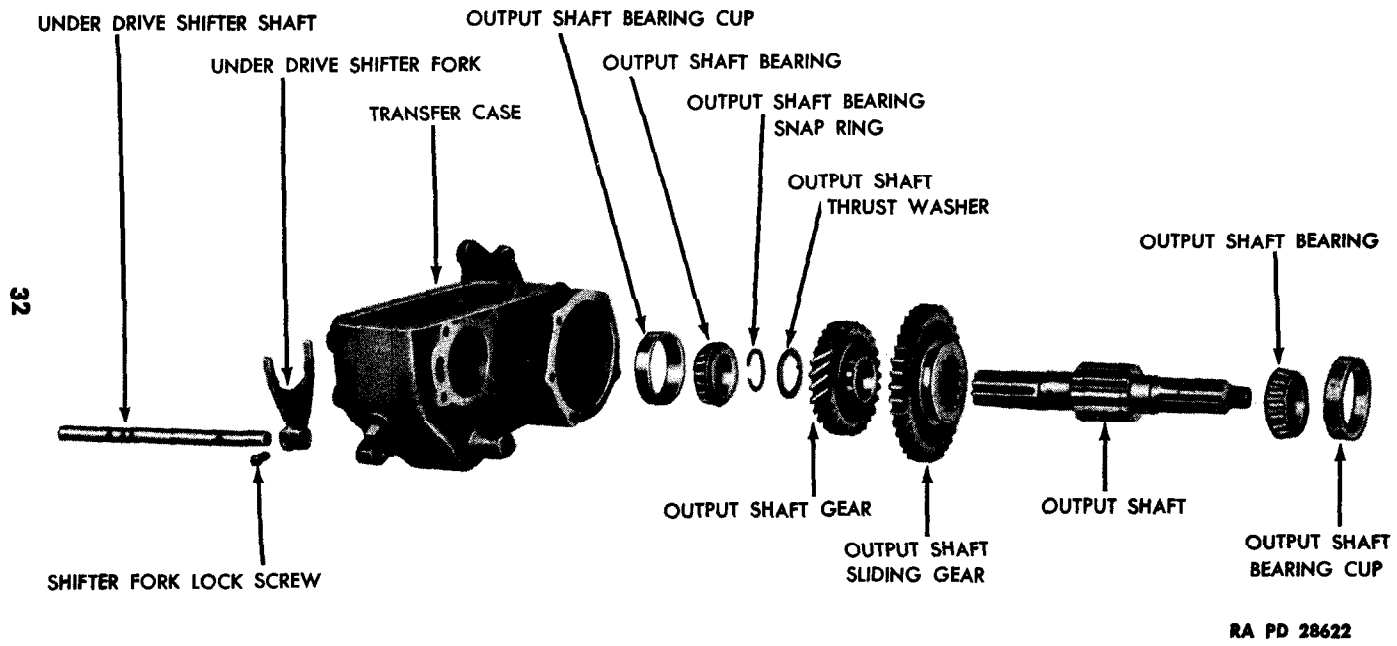
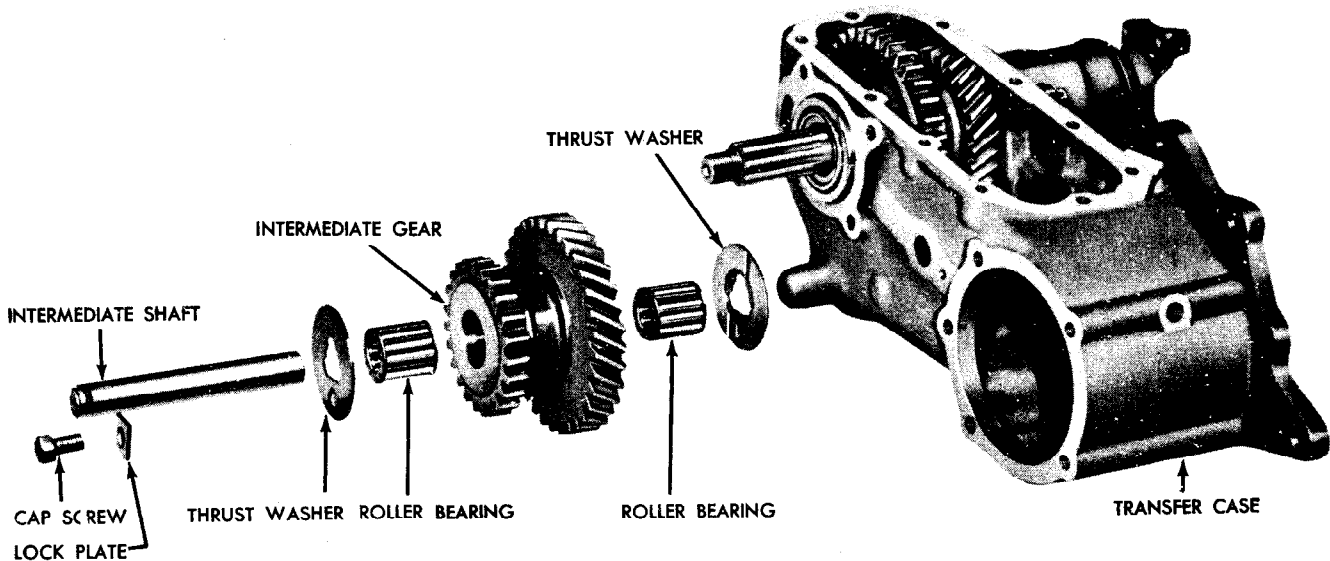
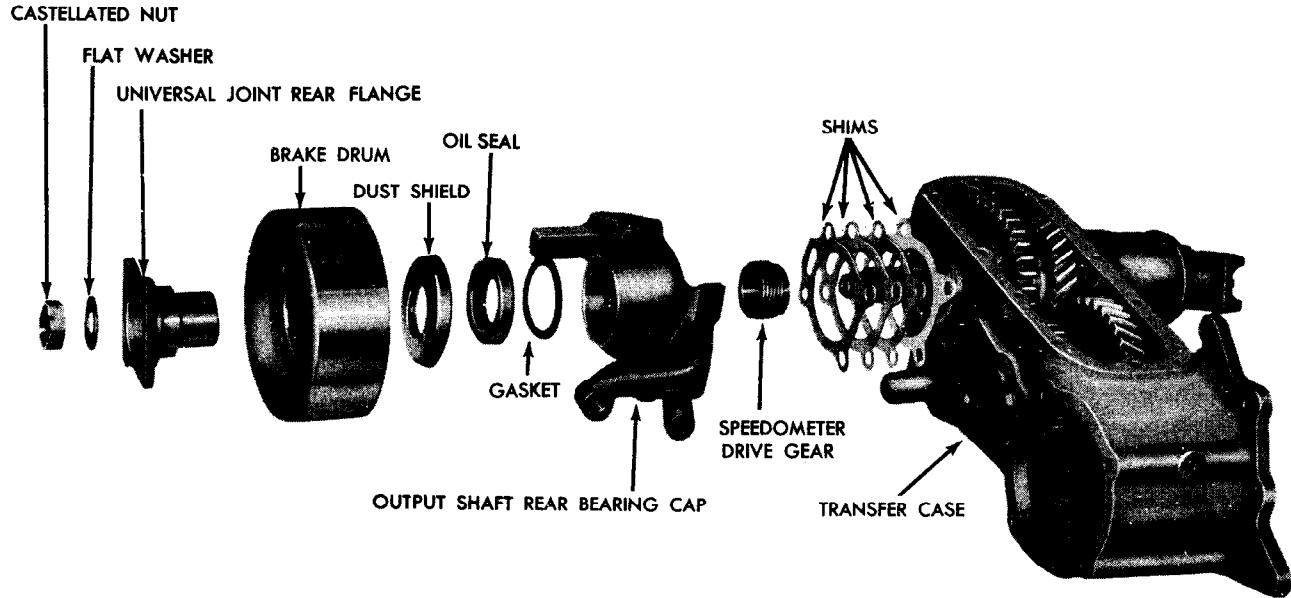


Figure 24 — Output Shaft — Exploded View



RA PD 28624

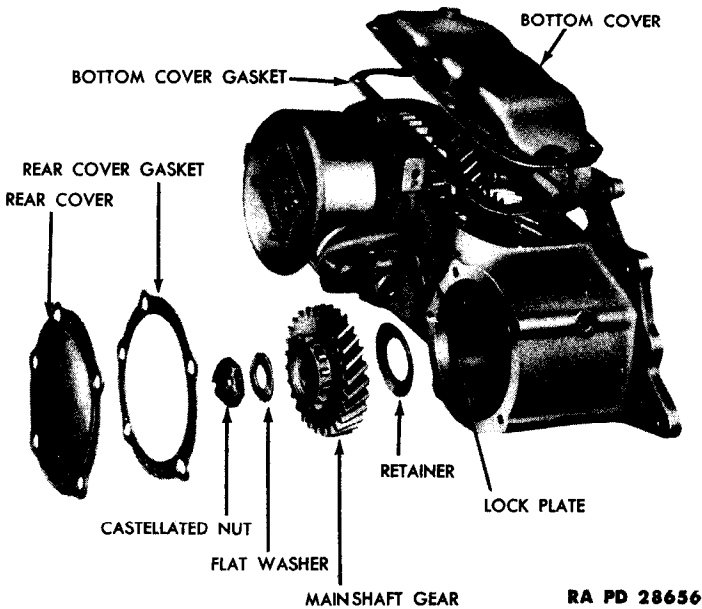
Figure 25 — Intermediate Gear Assembly — Exploded View



RA PD 28627

Figure 26 — Rear Output Shaft Cap — Exploded View

## POWER TRAIN



**Figure 27 – Bottom Cover and Mainshaft Gear – Exploded View**

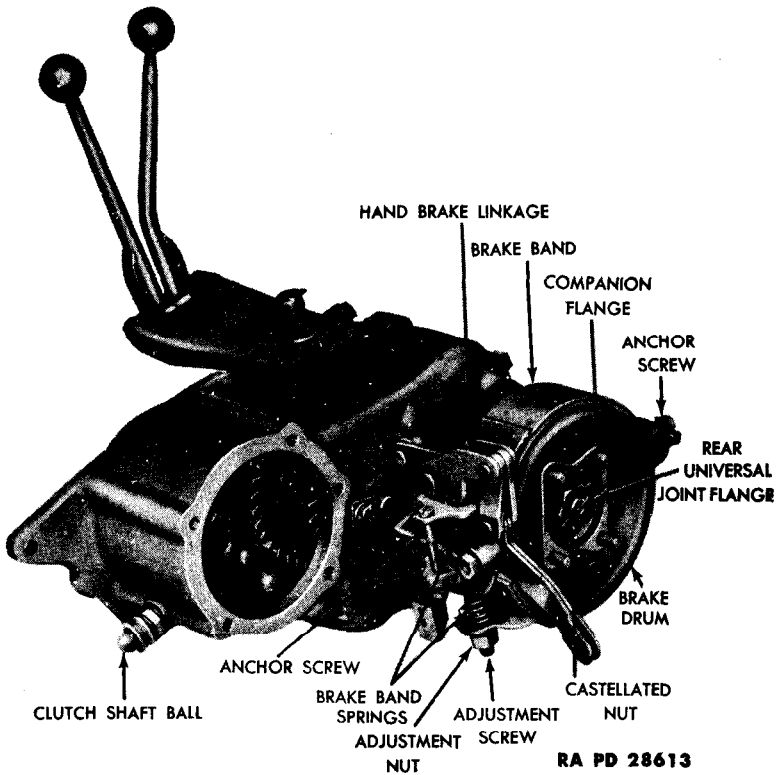
in the transfer case until the cup is slightly below flush with the transfer case. Tap the rear bearing cup in the transfer case until the cup is approximately  $\frac{1}{8}$  inch from the transfer case surface.

**d. Install Front Output Shaft Bearing Cap to Transfer Case** (figs. 21 and 22). Place a new gasket in position on the transfer case. Install the interlock (fig. 21) in the interlock opening on the bearing cap. Slide the front output shaft bearing cap on the under drive shifter shaft, being careful not to damage the oil seal in the output shaft bearing cap. Install the five bolts that secure the front bearing cap to the transfer case. Install the poppet ball, poppet spring and poppet plug on both sides of the front bearing cap (fig. 21).

**e. Install Intermediate Gear** (fig. 25). Insert the roller bearings in the intermediate gear. Place the thrust washers in the transfer case, with the side having the bronze facing, toward the intermediate gear. Apply grease to the thrust washers to hold them in position, if necessary. Place the intermediate gear between the thrust washers in the transfer case. Install the intermediate gear shaft in the transfer case. Install the lock plate that secures the intermediate gear shaft to the transfer case.

**f. Install Rear Output Shaft Cap to Transfer Case** (fig. 26). Slide the speedometer drive gear on the output shaft. Install the oil seal in

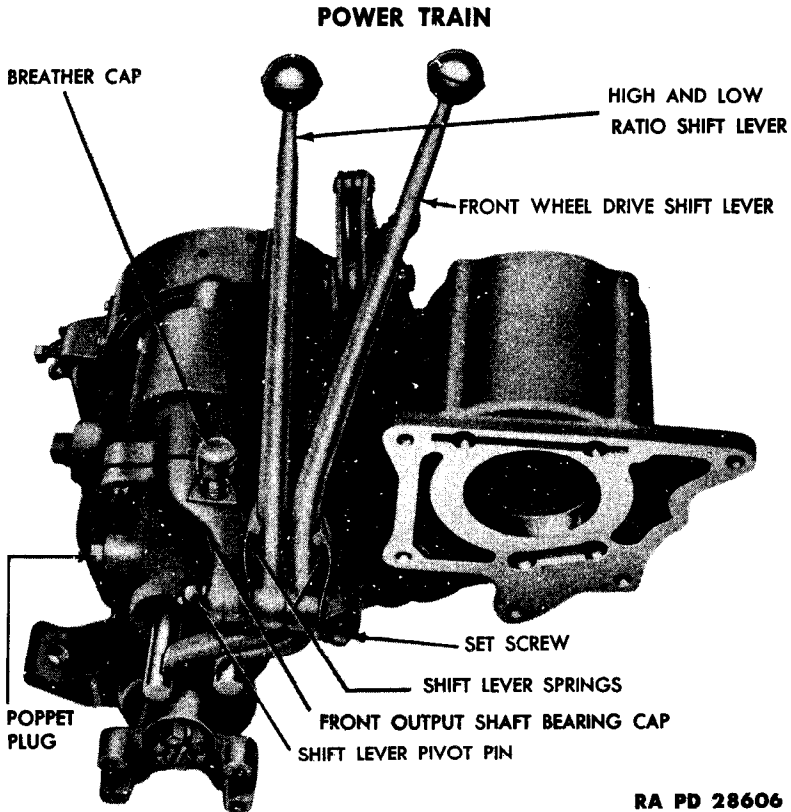
ORDNANCE MAINTENANCE — POWER TRAIN, BODY, AND FRAME FOR ¼-TON 4x4 TRUCK  
(WILLYS-OVERLAND MODEL MB AND FORD MODEL 6PW)



**Figure 28 — Transfer Case**

the rear output shaft cap (par. 13 c). Install the rear output shaft cap, shims and gasket on the transfer case. Tighten the four cap screws evenly to prevent cracking the output shaft cap. Shims are to be added or removed until the output shaft has no end play, but turns freely. When adjusting the bearings, each time shims are added, the shaft must be free before attempting to tighten the output shaft cap again. Insert the rear universal joint flange in the brake drum. Place the four cap screws in the brake drum and universal joint flange, using a suitable driver, drive the dust shield on the universal joint flange. Install the rear universal joint flange on the output shaft, and install the flat washer and nut.

**g. Install Bottom Cover to Transfer Case (fig. 27).** Install a new gasket in position on the transfer case. Place the bottom cover on the transfer case. Install the cap screws that secure the bottom cover to the transfer case.



**Figure 29 — Transfer Case Shift Levers**

**h. Install Brake Band to Transfer Case (fig. 28).** Place the brake band on the brake drum. Place the brake band springs between the rear output shaft bearing cap and the ends of the brake band. Install the nut and bolt that secure the hand brake linkage to the rear output shaft bearing cap. Insert the adjusting screw through the brake band linkage, brake band springs, and install the adjusting nut. Install the two anchor screws on the brake band.

## **15. INSTALLATION.**

**a. Raise Transfer Case.** Raise the transfer case and line up the clutch shaft ball joint in the transfer case. Line up the transfer case with the transmission. Be sure the interlock is in position on the rear of the transmission case before installing the transfer case to the transmission (fig. 4). Install the five cap screws that secure the transfer case to the transmission. Install the mounting bolt that secures the transfer case to the transmission support crossmember.

**ORDNANCE MAINTENANCE — POWER TRAIN, BODY, AND FRAME FOR ¼-TON 4 x 4 TRUCK  
(WILLYS-OVERLAND MODEL MB AND FORD MODEL GPW)**

b. **Install Mainshaft Gear** (fig. 27). Insert the retainer and mainshaft gear on the transmission mainshaft. Install the flat washer and castellated nut that secure the mainshaft gear on the transmission mainshaft. Place a new gasket and the rear cover on the transfer case and install the cap screws that secure the cover to the case.

c. **Install Clutch, Hand Brake and Speedometer Cables** (fig. 6). Install the clevis that secures the clutch release fork cable to the clutch shaft. Install the clevis pin that secures the hand brake cable to the brake band. Install the cap screw that secures the hand brake clamp to the transfer case rear output shaft cap. Install the speedometer cable to the transfer case at the top of the rear output shaft cap.

d. **Install Propeller Shaft and Transfer Case Shield** (fig. 6). Connect the rear propeller shaft to the transfer case (par. 17 b). Place the transmission shield in position and install the five cap screws that secure the shield to the transmission support crossmember. Install the exhaust pipe clamp to the transmission shield. Fill the transfer case with specified oil to the proper level. Adjust the hand brake band (refer to TM 9-803).

---

**Section IV**

**PROPELLER (DRIVE) SHAFTS AND UNIVERSAL JOINTS**

**16. DESCRIPTION AND TABULATED DATA.**

a. **Description** (fig. 2). The power from the transfer case is carried through two propeller shafts. One propeller shaft runs from the front of the transfer case to the front axle, and a second propeller shaft runs from the rear of the transfer case to the rear axle. Each is equipped with two universal joints. The splined slip joint at one end of each shaft allows for variations in distance between the transfer case and the axle units due to spring action. Two types of universal joints are used; the U-bolt type and the solid yoke type.

**b. Tabulated Data.**

**(1) PROPELLER SHAFTS.**

Make .....	Spicer
Shaft diameter .....	1½ in.
Length (front) .....	21½ <sub>16</sub> in.
Length (rear) .....	20½ <sub>32</sub> in.

## POWER TRAIN

### (2) FRONT PROPELLER SHAFT FORWARD UNIVERSAL JOINT.

Make ..... Spicer  
Type ..... U-bolt and solid yoke  
Model ..... 1268  
Bearings ..... Needle roller

### (3) FRONT PROPELLER SHAFT REAR UNIVERSAL JOINT.

Make ..... Spicer  
Type ..... U-bolt and solid yoke  
Model ..... 1261  
Bearings ..... Needle roller

### (4) REAR PROPELLER SHAFT FORWARD UNIVERSAL JOINT.

Make ..... Spicer  
Type ..... Solid yoke slip joint  
Model ..... 1261  
Bearings ..... Needle roller

### (5) REAR PROPELLER SHAFT REAR UNIVERSAL JOINT.

Make ..... Spicer  
Type ..... U-bolt and solid yoke  
Model ..... 1268  
Bearings ..... Needle roller

## 17. REMOVAL.

a. **Front Propeller Shaft (fig. 33).** Bend the ears of the lock plates off the U-bolt nuts. Remove the two nuts from each of the two U-bolts at the front axle and at the transfer case. Remove the U-bolts from the propeller shaft. Take care to hold the bearing races in place on the universal joint to avoid losing the rollers.

b. **Rear Propeller Shaft (fig. 34).** The rear propeller shaft is similar to the front propeller shaft with the exception of the solid yoke type connection at the transfer case. Remove the nuts from the U-bolts at the rear axle end. Remove the U-bolts. Slide the universal joint out of the universal joint rear flange. Care must be taken to hold the bearing races on the universal joint to avoid losing the rollers. Remove the four nuts that secure the universal joint flange yoke to the rear flange at the transfer case. Remove the rear propeller shaft from the vehicle.

ORDNANCE MAINTENANCE — POWER TRAIN, BODY, AND FRAME FOR 1/4-TON 4x4 TRUCK  
(WILLYS-OVERLAND MODEL MB AND FORD MODEL 6PW)

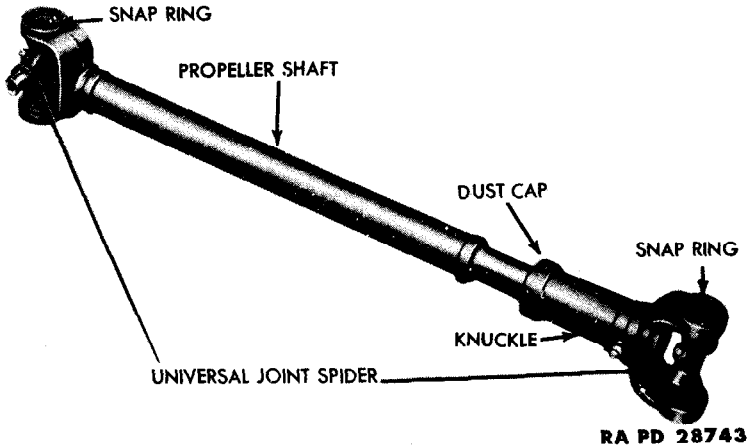


Figure 30 — Front Propeller Shaft

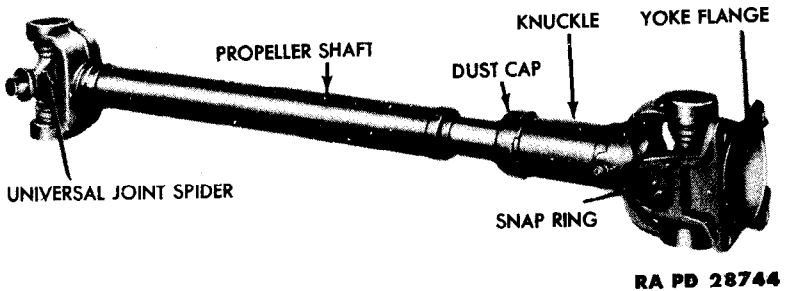


Figure 31 — Rear Propeller Shaft

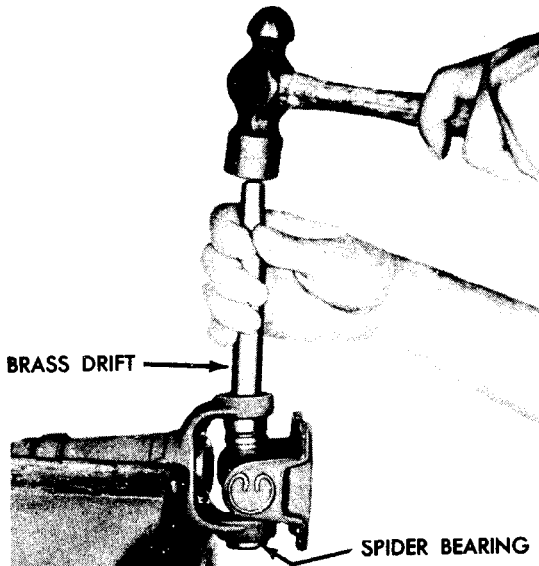
18. DISASSEMBLY.

a. Front Propeller Shaft (fig. 30).

(1) REMOVE SNAP RINGS FROM YOKE (fig. 30). Place the propeller shaft in a vise. Remove the snap rings that secure the spider bearings in the yoke flange with a pair of pliers. If the snap ring does not snap out of the groove, tap the end of the bearing lightly. This will relieve the pressure against the snap ring.

(2) REMOVE SPIDER FROM YOKE (fig. 32). Drive lightly on the end of the spider bearing until the opposite bearing is pushed out of the yoke flange. Turn the assembly over in the vise and drive the first spider bearing back out of its lug by driving on the exposed end of the spider. Use a brass drift with a flat face about  $\frac{1}{32}$  inch smaller

## POWER TRAIN



RA PD 28745

**Figure 32 — Removing Spider Bearing**

in diameter than the hole in the yoke, otherwise there is danger of damaging the spider bearing. Repeat this operation for the other two bearings, then lift out the spider, sliding to one side and tilting over the top of the yoke.

(3) **REMOVE KNUCKLE FROM SHAFT** (fig. 30). Bend the ears of the dust cap off the knuckle. Slide the knuckle off the drive shaft. Remove the split cork gasket from the bearing cap. Line up the slots in the dust cap with the splines on the drive shaft and remove the cap from the shaft.

**b. Rear Propeller Shaft.**

(1) **REMOVE YOKE FLANGE** (fig. 31). Place the propeller shaft in a vise. Remove the four snap rings that secure the spider bearings in the yoke flange and knuckle. Using a brass drift with a flat face about  $\frac{1}{32}$  inch smaller than the hole in the yoke, drive lightly on the end of the bearing until the opposite bearing is out of the yoke flange. Turn the assembly over in the vise and drive the first bearing out of its lug by driving on the exposed end of the spider. Remove the yoke flange from the spider.

(2) **REMOVE SPIDER AND KNUCKLE** (fig. 32). Remove the spider from the knuckle (subpar. a (2), above). Remove the knuckle from the propeller shaft (subpar. a (3), above).



## POWER TRAIN

### 19. CLEANING, INSPECTION, AND REPAIR.

a. Clean all parts thoroughly with dry-cleaning solvent. Inspect the drive shafts for cracks, broken welds, scored spider bearing surfaces, or bent shafts. Parts with any of these faults must be replaced. Inspect the knuckle for worn splines, worn bearing surfaces and bearings and plugged lubricant fittings. Check the diameter of the machined surface of the spiders. If the diameter is less than 0.595 inch, replace the spider. Replace all grease seals regardless of their condition.

### 20. ASSEMBLY.

a. **Front Propeller Shaft** (fig. 33). Place the propeller shaft in a vise. Slide the dust cap on the drive shaft. Place a new cork gasket in the cap. Slide the knuckle on the shaft splines, being sure that the knuckle on the shaft is in the same angle as the yoke at the opposite end of the propeller shaft. Slide the dust cap on the shoulder of the knuckle and bend the ears of the cap over the shoulder of the knuckle.

#### b. **Rear Propeller Shaft** (fig. 34).

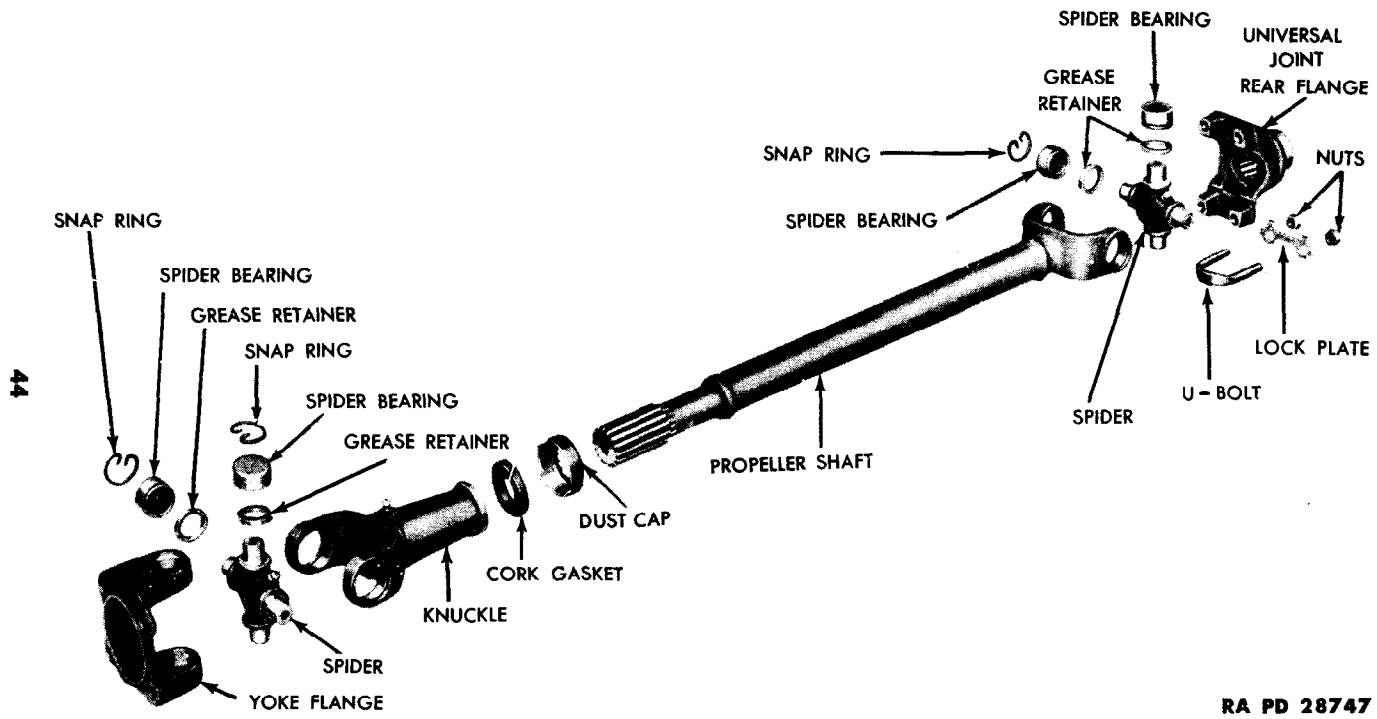
(1) **INSTALL SPIDER IN YOKE FLANGE** (fig. 34). Insert the spider into the yoke flange. Tap the spider bearing approximately  $\frac{1}{4}$  inch into the yoke flange, using a brass drift approximately  $\frac{1}{32}$  inch smaller than the hole in the yoke. Tap the other bearing into the opposite end of the yoke flange until the bearing is in line with the snap ring grooves. With a pair of pliers, install the snap rings on both ends of the yoke flange. Insert the flange assembly in the knuckle. Tap the bearing approximately  $\frac{1}{4}$  inch into the yoke. Place the other bearing into the opposite end of the yoke, and tap this bearing into the yoke until the bearing is in line with the snap ring groove. Install the snap rings on both ends of the yoke.

(2) **INSTALL KNUCKLE AND SPIDERS** (fig. 34). Install the knuckle on the propeller shaft (subpar. a (1), above).

### 21. INSTALLATION.

a. **Rear Propeller Shaft**. Place the propeller shaft with the yoke flange end toward the transfer case (fig. 6). Install the four nuts that secure the yoke flange to the transfer case. Insert the two spider bearings on the spider at the rear axle end. Place the spider in the universal joint rear flange. Install the two U-bolts that secure the propeller shaft to the rear axle flange. Lubricate the propeller shaft with specified lubricant.

b. **Front Propeller Shaft**. Place the propeller shaft with the knuckle end at the transfer case. Insert the bearings on the spider



44

RA PD 28747

Figure 34 — Rear Propeller Shaft — Exploded View

**POWER TRAIN**

and place the propeller shaft in the universal joint flange on the transfer case. Install the two U-bolts that secure the propeller shaft to the transfer case. Insert the two spider bearings on the spider at the front axle end. Place the propeller shaft in the front axle flange. Install the two U-bolts that secure the propeller shaft to the universal joint flange. Lubricate the propeller shaft with specified lubricant.

**Section V**

**FRONT AXLE**

**22. DESCRIPTION AND DATA.**

a. **Description** (fig. 2). The front axle assembly is a front wheel driving unit, with specially designed spindle housings, and has a conventional type differential with hypoid drive gears. The differential parts are interchangeable with those of the rear axle. The axle shafts are of the full-floating type. The differential is mounted in the housing similar to the rear axle, except that the drive pinion shaft is toward the rear instead of the front and to the right of the center of the axle. Three types of axle shafts and universal joints have been used (Rzeppa, Bendix, and Tracta). The vehicles using the different types of shafts are identified by an identification tag attached to the spindle housing (fig. 35).

b. **Data.**

(1) **FRONT AXLE.**

Make ..... Spicer  
 Drive ..... Through springs  
 Type ..... Full-floating

(2) **DIFFERENTIAL.**

Drive ..... Hypoid  
 Gear ratio ..... 4.88 to 1  
 Bearings ..... Timken roller 2  
 Adjustment ..... Shims  
 Gears (pinion) ..... 2

(3) **OIL CAPACITY** ..... 2½ pt

ORDNANCE MAINTENANCE — POWER TRAIN, BODY, AND FRAME FOR ¼-TON 4x4 TRUCK  
(WILLYS-OVERLAND MODEL MB AND FORD MODEL GPW)



Figure 35 — Front Axle Assembly in Vehicle

**A**— SPRING SHACKLE  
**B**— SHOCK ABSORBER  
**C**— TIE ROD  
**D**— BREATHER CAP  
**E**— TIE ROD ENDS  
**F**— SPRING SHACKLE  
**G**— TIE ROD  
**H**— LEFT FRONT SPRING  
**J**— SHOCK ABSORBER  
**K**— TIE ROD CLAMP  
**L**— TORQUE REACTION SPRING  
**M**— DRAG LINK  
**N**— DRAG LINK PLUG  
**O**— PIVOT ARM  
**P**— DRAIN PLUG  
**Q**— FRONT PROPELLER SHAFT  
**R**— SPRING SEAT PLATE  
**S**— TIE ROD CLAMP  
**T**— TIE ROD ENDS  
**U**— RIGHT FRONT SPRING  
**V**— TIE ROD CLAMPS  
**W**— AXLE SHAFT IDENTIFICATION TAG

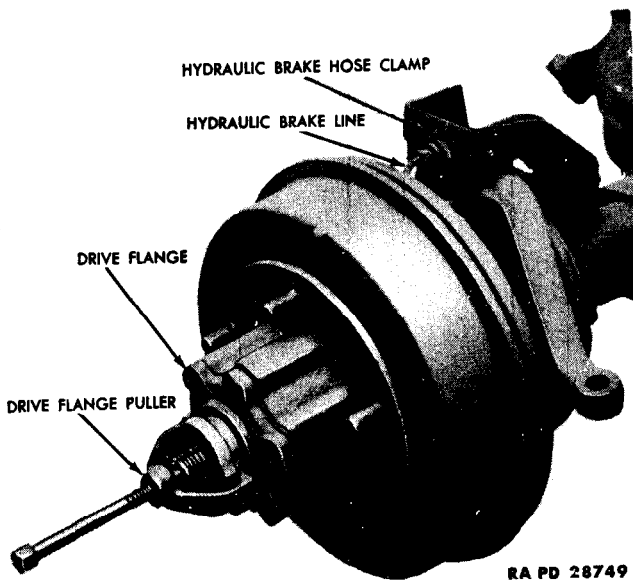
RA PD 329205 - 8

**Legend for Figure 35 – Front Axle Assembly in Vehicle**

POWER TRAIN

TM 9-1803B  
22

ORDNANCE MAINTENANCE — POWER TRAIN, BODY, AND FRAME FOR ¼-TON 4x4 TRUCK  
(WILLYS-OVERLAND MODEL MB AND FORD MODEL GPW)



RA PD 28749

**Figure 36 — Removing Drive Flange With Puller Similar to Puller 41-P-2912**

### 23. REMOVAL.

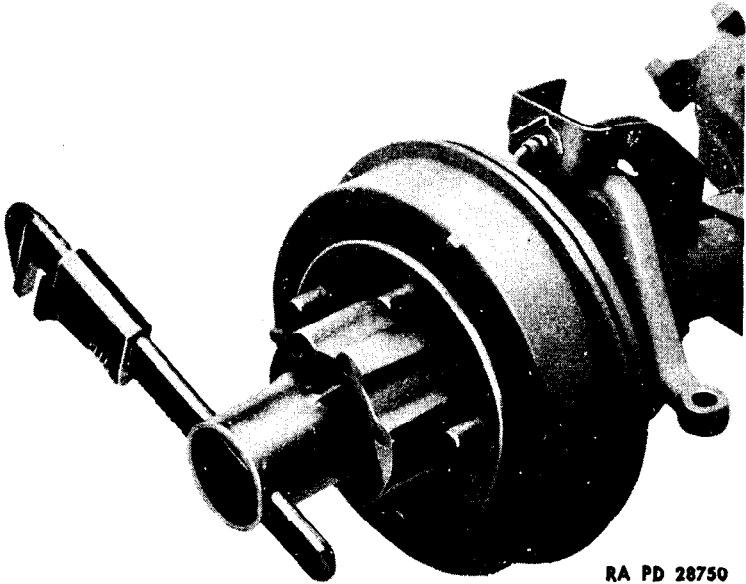
a. **Preliminary Work.** Remove the drain plug at the differential housing and drain the oil. Raise the vehicle until the weight is off the front springs.

b. **Disconnect Shock Absorbers and Drag Link (fig. 35).** Remove the cotter pin and flat washer that secure the shock absorber to the spring seat plate at both front shock absorbers. Remove the drag link plug at the pivot arm. Remove the drag link from the pivot arm.

c. **Disconnect Front Propeller Shaft and Spring U-bolts (fig. 35).** Disconnect the front propeller shaft at the front axle (par. 17 a). Remove the four nuts from the two U-bolts that secure the spring seat plate. Remove the spring seat plate and U-bolts. Remove the four nuts from the U-bolts at the torque reaction spring. Remove the two U-bolts.

d. **Disconnect Spring Shackles (fig. 35).** Remove the lower spring shackle bushing at the forward end of the front springs. Pull both springs out of the spring shackles and drop the forward end of the springs to the floor. Roll the front axle assembly from the vehicle.

POWER TRAIN



RA PD 28750

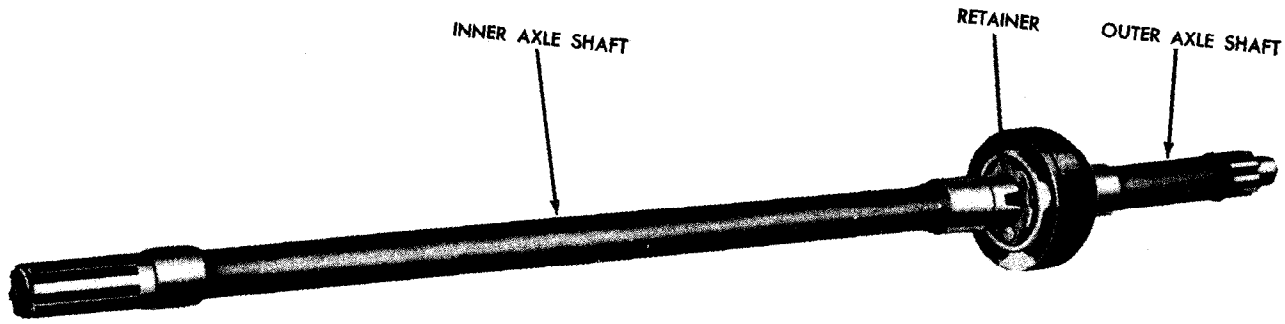
**Figure 37 — Removing Bearing Lock Nut With Wrench 41-W-3825-200**

**24. DISASSEMBLY.**

a. **Remove Wheels.** Place the front axle assembly on two blocks. Remove the five nuts that secure the wheels to the brake drum. Remove the wheels.

b. **Remove Axle Shaft Assembly.** Using a screwdriver, pry the hub cap off the drive flange. Remove the cotter pin and castellated nut from the axle shaft. Remove the six cap screws that secure the drive flange to the hub. Install the puller 41-P-2912 or similar on the drive flange and remove the drive flange (fig. 36). Bend the ear of the lock washer off the bearing lock nut. Remove the bearing lock nut, lock washer, and bearing adjustment nut, using the wheel bearing nut wrench 41-W-3825-200 furnished with the vehicle (fig. 37). Slide the brake drum and hub assembly, including the wheel bearings, off the spindle. Disconnect the hydraulic brake line at the brake hose guard (fig. 36). Remove the six cap screws that secure the brake plate to the spindle housing. Remove the brake plate from the spindle. Slide the spindle off the axle shaft. The axle shaft can now be removed from the housing. If equipped with a Tracta universal joint axle shaft, see subparagraph c, below. Use the same procedure to disassemble the other end of the front axle shaft.

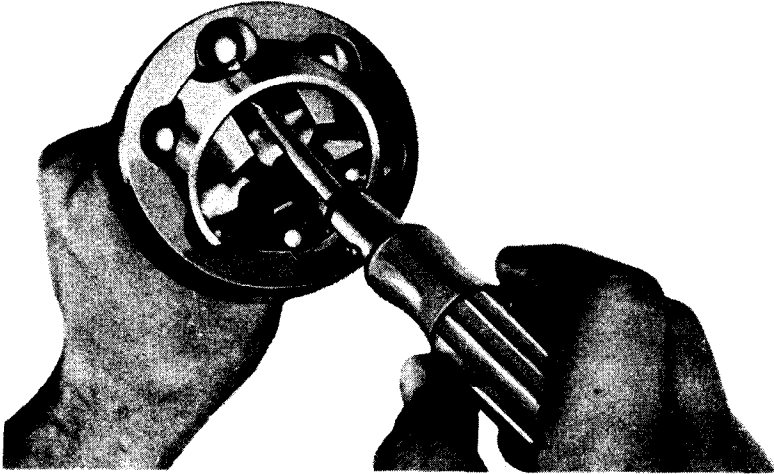
c. **Axle Shaft Disassembly.** Three types of axle shaft universal joints, as shown in figures 38, 42, and 44, are used in the front axle.



**RA PD 28751**

**Figure 38 — Front Axle Shaft (Rzeppa Joint)**

POWER TRAIN



RA PD 28752

**Figure 39 — Removing Balls From Cage**

Disassembly procedures for each are given in steps (1), (2), and (3), below.

(1) **RZEPPA UNIVERSAL JOINT.**

(a) *Remove Inner Axle Shaft* (fig. 59). Remove the three flat head screws that secure the retainer to the inner ball race. Slide the inner axle shaft out of the universal joint. Remove the pilot pin from the outer axle shaft. If the pilot pin does not drop out of the outer axle shaft, hold the shaft upside down and tap the shaft on a piece of wood.

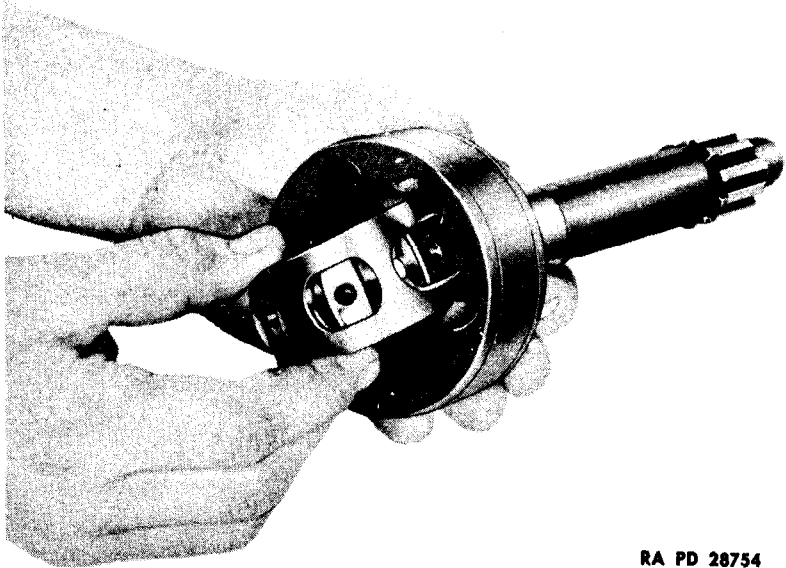
(b) *Remove Balls From Cage* (fig. 39). Tilt the cage in the axle shaft cup until the opposite side of the cage is out of the housing. It may be necessary to use a brass drift and hammer to tilt the cage. Use a screwdriver to pry the steel ball out of the cage. Repeat this operation until all the balls are removed.

(c) *Remove Cage and Inner Race From Axle Shaft* (fig. 40). Turn the cage in the axle shaft cup in line with the shaft and with the two larger elongated holes between two bosses in the shaft. Lift the cage and inner race from the axle shaft cup.

(d) *Remove Inner Race From Cage* (fig. 41). Turn the inner race in the cage so that one of the bosses on the inner race can be dropped into one of the two elongated holes in the cage. Remove the inner race from the cage.

(2) **BENDIX UNIVERSAL JOINT** (figs. 42 and 43). Place the axle

**ORDNANCE MAINTENANCE — POWER TRAIN, BODY, AND FRAME FOR 1/4-TON 4 x 4 TRUCK  
(WILLYS-OVERLAND MODEL MB AND FORD MODEL GPW)**



**RA PD 28754**

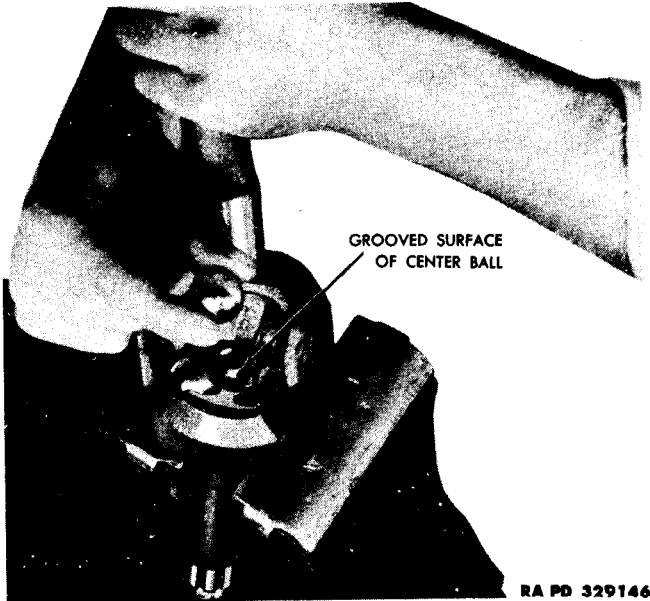
**Figure 40 — Removing Cage and Inner Race From Axle Shaft  
(Rzeppa Joint)**



**RA PD 28753**

**Figure 41 — Removing Inner Race From Cage (Rzeppa Joint)**

POWER TRAIN

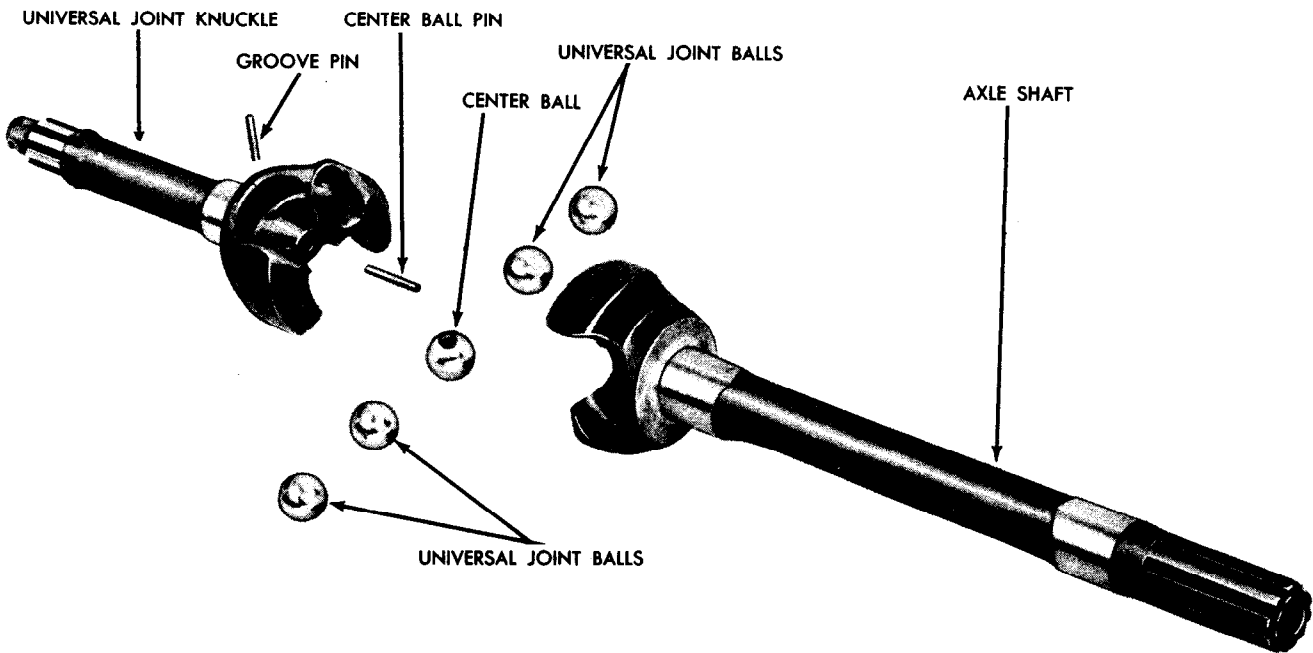


**Figure 42 — Front Axle Shaft (Bendix Type)**

shaft in a vise and with a long nosed drift remove the groove pin from the universal joint knuckle. Remove the axle shaft from the vise. Tap the knuckle end of the axle shaft on a wood block until the center ball pin drops in the groove pin hole. Place the axle shaft with the knuckle end (short end) in a vise. Bend the axle shaft so that the center ball can be rotated until the grooved surface of the center ball is facing the first ball that is to be removed. Holding the axle shaft in a bent position, raise the shaft until the first ball to be removed slides into the groove of the center ball, and remove the ball. Remove the axle shaft from the knuckle. The three remaining balls will drop out of the knuckle.

(3) **TRACTA UNIVERSAL JOINT** (fig. 45). Remove the outer portion of the axle shaft and the outer portion of the universal joint from the axle housing. Pull the inner portion of the axle shaft and the inner portion of the universal joint out of the housing.

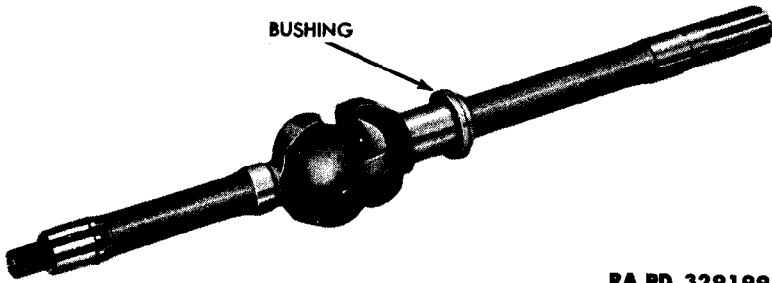
d. **Remove Spindle Housing** (fig. 46). Remove the castellated nut that secures the tie rod ends to the two spindle arms. Remove the two castellated nuts that secure the two tie rod ends to the steering pivot arm and remove the two tie rods. Remove the hydraulic brake hose clamp from the hydraulic brake line at the brake hose guard. Remove the four nuts that secure the brake hose guard and spindle arm to the spindle housing. Remove the spindle arm and



RA PD 329147

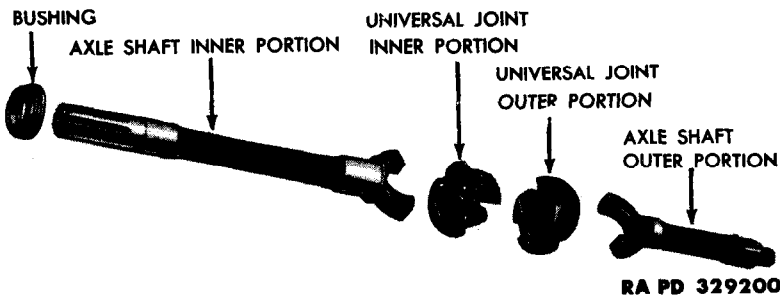
Figure 43 — Front Axle Shaft — Exploded View (Bendix Type)

POWER TRAIN



RA PD 329199

Figure 44 – Front Axle Shaft (Tracta Type)



RA PD 329200

Figure 45 – Front Axle Shaft – Exploded View (Tracta Type)

shims from the spindle housing. Remove the four cap screws that secure the lower bearing cap to the spindle housing. Remove the bearing cap and shims. Remove the eight cap screws that secure the spindle housing oil seal retainer to the spindle housing. Remove the spindle housing from the axle housing. Use the same procedure for disassembling the other spindle housing.

e. **Remove Differential (fig. 47).** Remove the ten cap screws that secure the differential cover to the differential housing. Remove the differential cover and gasket. Remove the two cap screws from the bearing cap at each end of the differential gears and remove the caps. Remove the differential gear assembly from the housing, using a pry bar, if necessary. Reinstall the bearing caps in the housing, noting the markings (fig. 47) to assure their being installed in their correct location.

f. **Disassemble Differential.**

(1) **REMOVE DIFFERENTIAL PINION GEARS AND AXLE SHAFT GEARS (fig. 48).** Place the differential assembly in a vise equipped with brass jaws. With a long nosed drift, drive the differential

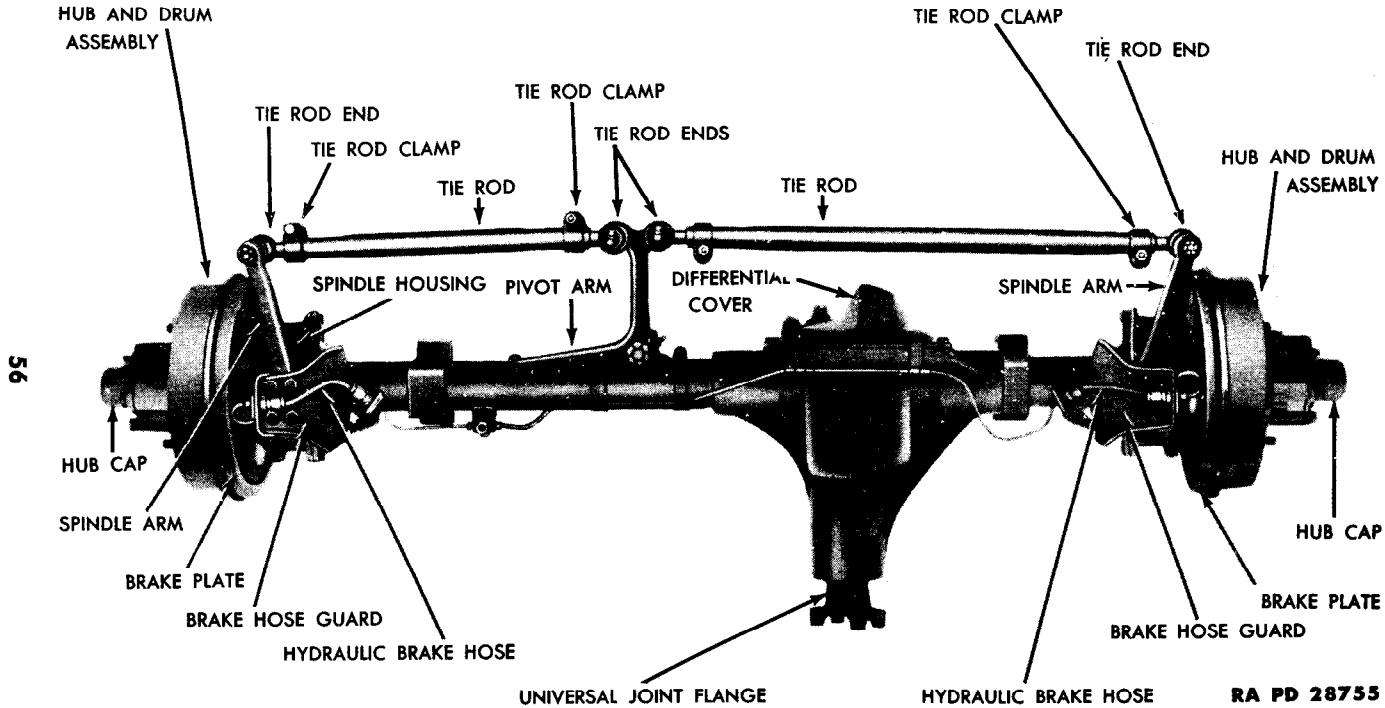
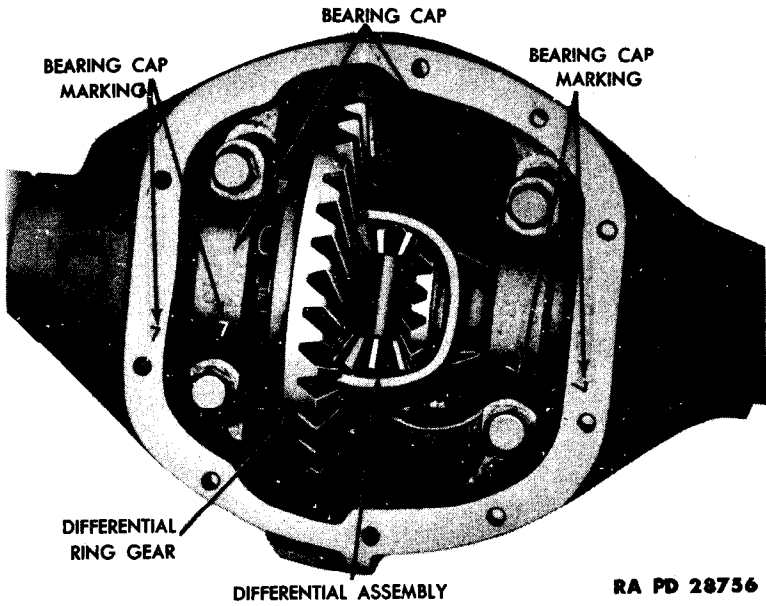


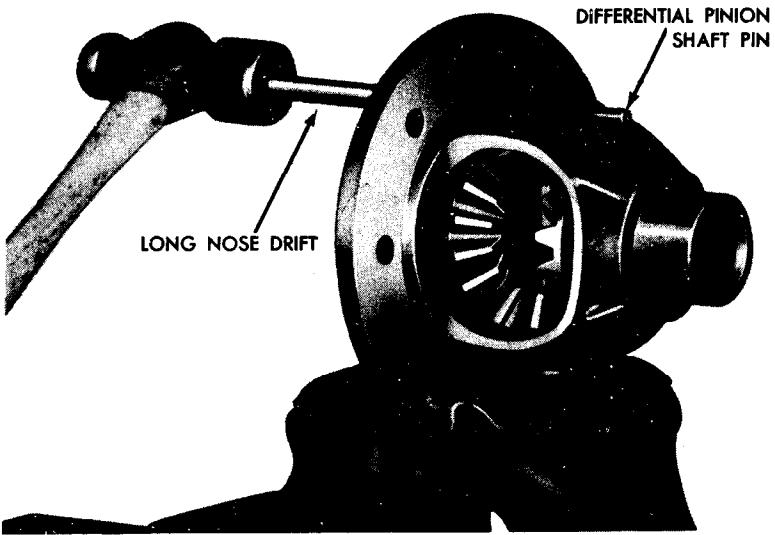
Figure 46 — Front Axle Assembly

**POWER TRAIN**



RA PD 28756

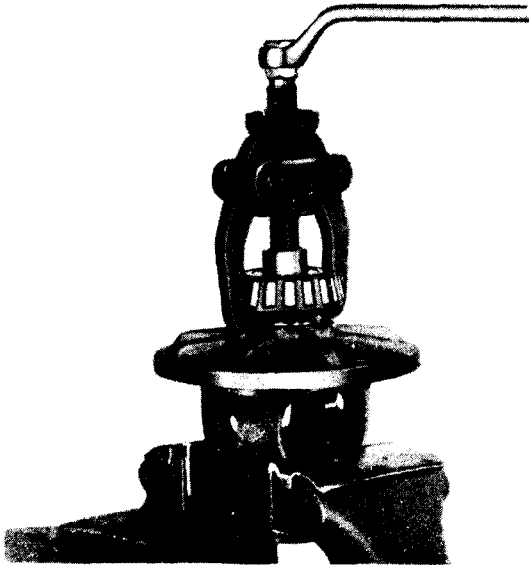
*Figure 47 – Differential Assembly*



RA PD 28758

*Figure 48 – Removing Pinion Shaft Lock Pin*

ORDNANCE MAINTENANCE — POWER TRAIN, BODY, AND FRAME FOR ¼-TON 4 x 4 TRUCK  
(WILLYS-OVERLAND MODEL MB AND FORD MODEL GPW)



RA PD 26757

**Figure 49 — Removing Bearings From Differential Case With Special Tool 41-R-2378-30**

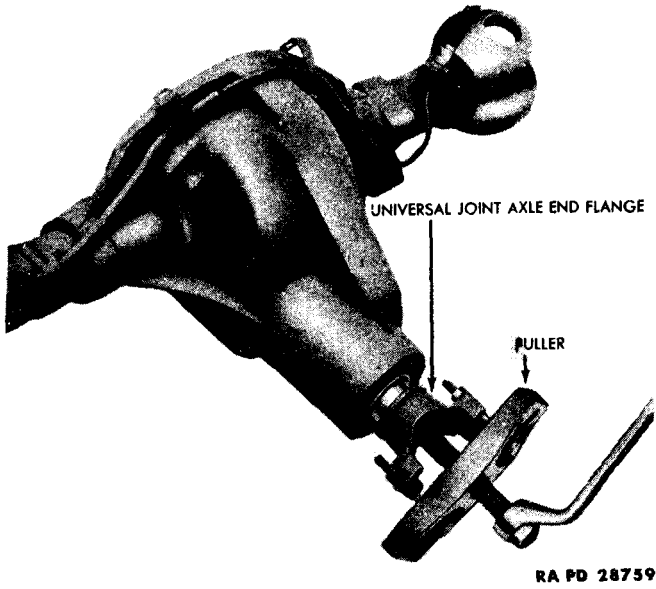
pinion shaft tapered pin out of the differential gear case. Tap the differential pinion shaft from the case with a brass drift and hammer. Remove the two differential pinion gears and thrust washers and the two axle shaft gears and thrust washers from the case.

(2) **REMOVE RING GEAR FROM CASE** (fig. 47). Bend the ears of the lock plates off the cap screws. Remove the cap screws that secure the ring gear to the case, and remove the ring gear.

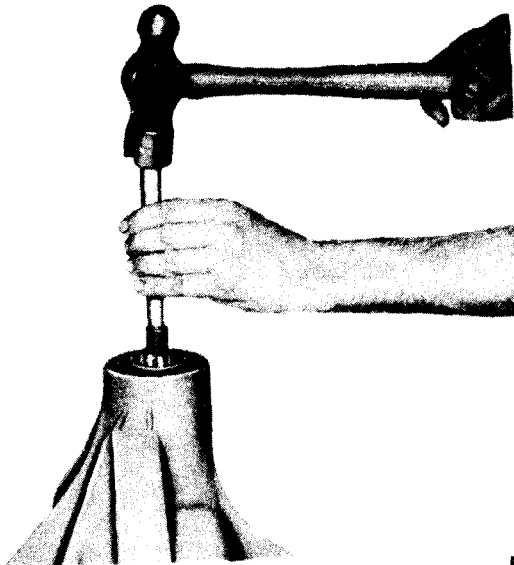
(3) **REMOVE ROLLER BEARING FROM DIFFERENTIAL CASE** (fig. 49). Place the differential case in a vise. Install the bearing remover 41-R-2378-30 to the roller bearing. Remove the roller bearing from each end of the differential case. Remove the shims, noting the thickness of the shims removed from each end.

**g. Remove Drive Pinion.** Remove the nut and flat washer that secure the universal joint flange to the drive pinion. Install the puller 41-P-2905-60 to the universal joint flange (fig. 50) and remove the flange. Using a brass drift and hammer, drive the drive pinion out of the axle housing (fig. 51). Remove the shims and spacer from the drive pinion, noting the thickness of the shims removed from the pinion.

POWER TRAIN

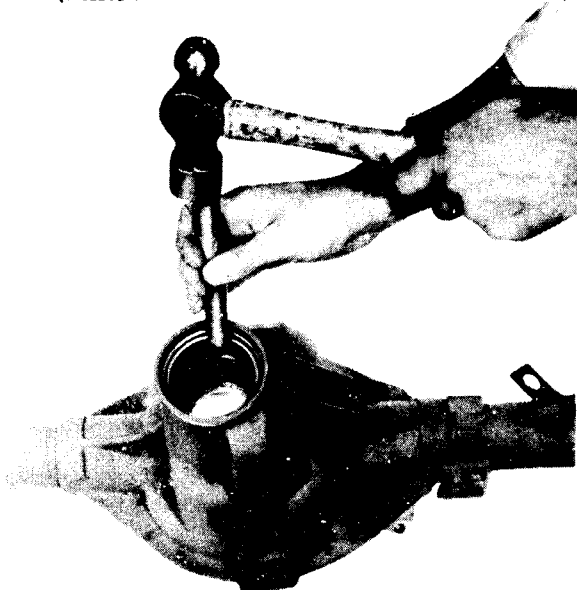


**Figure 50 – Removing Universal Joint Axle End Flange With Puller 41-P-2905-60**



**Figure 51 – Removing Drive Pinion**

ORDNANCE MAINTENANCE — POWER TRAIN, BODY, AND FRAME FOR ¼-TON 4 x 4 TRUCK  
(WILLYS-OVERLAND MODEL MB AND FORD MODEL GPW)



RA PD 28761

**Figure 52 — Installing Pinion Outer Bearing Cup**

## 25. CLEANING, INSPECTION, AND REPAIR.

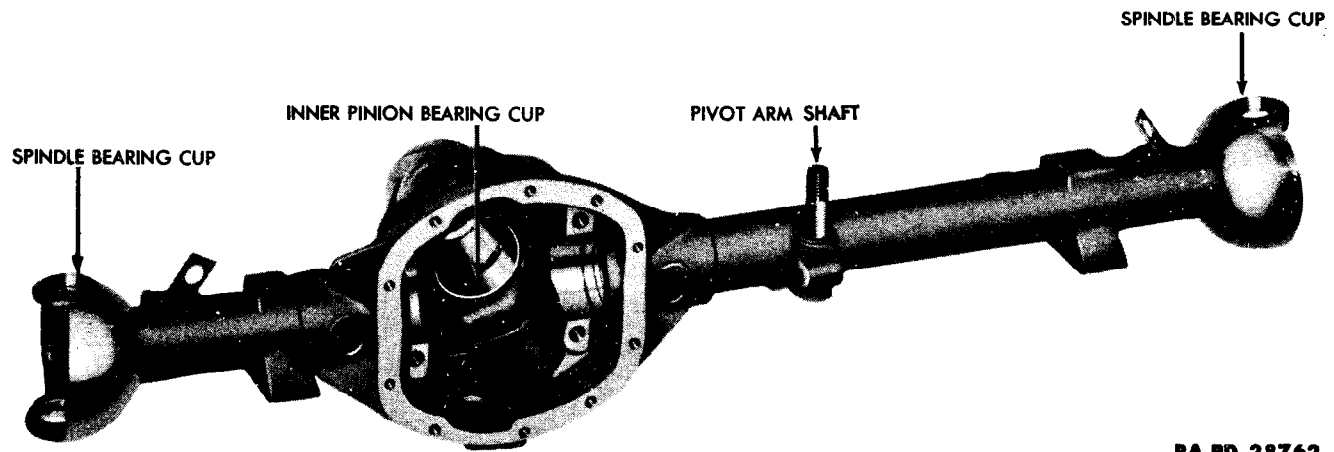
a. **Cleaning.** Clean all parts in dry-cleaning solvent. Rotate the bearings while immersed in the dry-cleaning solvent until all trace of lubricant has been removed. Oil the bearings to prevent corrosion of the highly polished surface unless they are to be used immediately.

### b. Inspection and Repair.

#### (1) AXLE HOUSING (fig. 53).

(a) **Inspection.** Replace the axle housing if it is bent or has any broken welds or cracks. Drive pinion bearing cups that are pitted, corroded or discolored due to overheating must be replaced (step (c), below). Spindle housing bearing cups that are pitted or corroded must be replaced (step (d), below). Replace the oil seals in the axle housing regardless of their condition (step (e), below). Replace the differential cover, if cracked or if it has damaged threads in the filler plug hole. Check the cover for missing or damaged breather cap. Check the steering pivot arm shaft. If the diameter is less than 0.747 inch, replace the pivot shaft (step (b), below). If the front axle is equipped with a Tracta type axle shaft, measure the

61



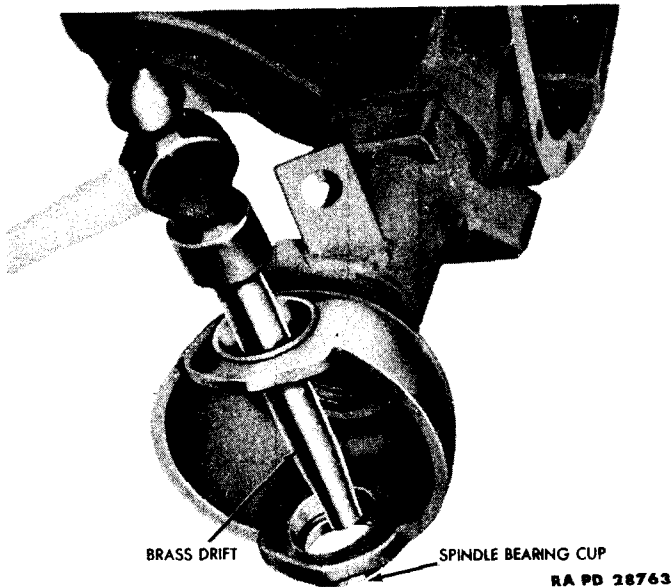
RA PD 28762

Figure 53 — Front Axle Housing

POWER TRAIN

TM 9-1803B  
25

ORDNANCE MAINTENANCE — POWER TRAIN, BODY, AND FRAME FOR ¼-TON 4 x 4 TRUCK  
(WILLYS-OVERLAND MODEL MB AND FORD MODEL GPW)



**Figure 54 — Removing Spindle Bearing Cup From Axle Housing**

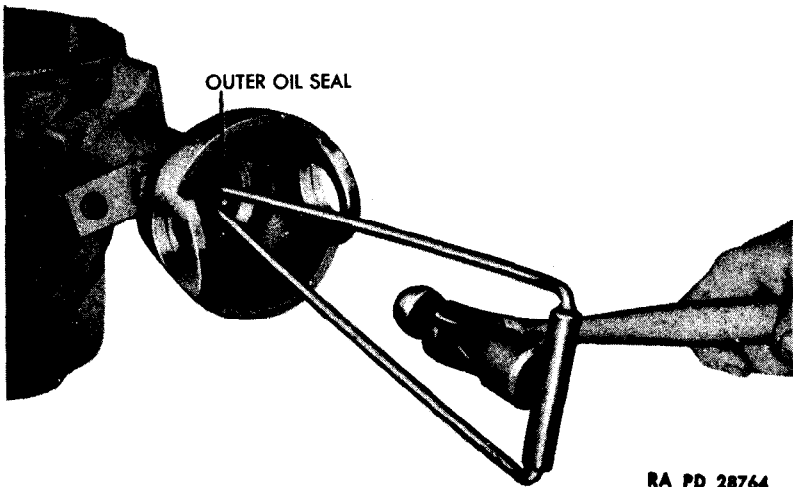
inside diameter of the housing at each end of the axle housing. If the bushing is worn to more than 1.285 inch, replace the bushing (step (f), below).

(b) *Pivot Arm Shaft Replacement* (fig. 53). With a long nosed drift, drive out the dowel that secures the pivot arm shaft to the axle housing. Tap the shaft out of the housing. To install a new pivot arm shaft, insert it in the bracket on the housing with the dowel slot in line with the dowel hole. Drive dowel in place.

(c) *Drive Pinion Bearing Cup Replacement*. Remove the inner and outer bearing cups, using a standard puller, noting the thickness of the shims when removing the inner bearing cup. To install new bearing cups, use a brass drift and hammer. Place the original thickness of shims behind the inner bearing cup and tap the bearing cups lightly around the entire circumference until flush with the shoulder in the axle housing (fig. 52).

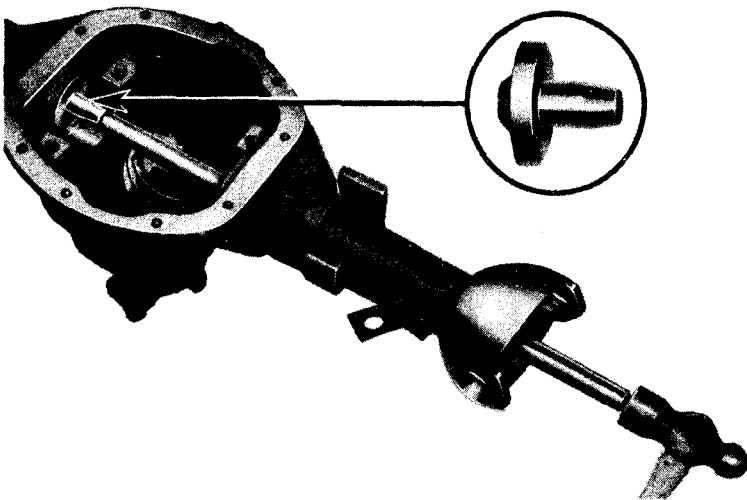
(d) *Spindle Housing Bearing Cup Replacement*. Working through one of the bearing cups, tap the opposite bearing cup out of the axle housing, using a brass drift and hammer (fig. 54). To install new bearing cups, place the bearing cup in position and tap the cup lightly until it is flush with the shoulder in the axle housing.

POWER TRAIN



RA PD 28764

**Figure 55 — Removing Oil Seal From Outer End of Axle Housing With Remover 41-R-2384-38**



RA PD 28765

**Figure 56 — Installing Oil Seal, With Replacer 41-R-2391-20**

(e) *Oil Seal Replacement* (fig. 55). To remove the outer axle shaft oil seal, remove the oil seal retainer. Use a screwdriver to pry the retainer out of the housing. Use the oil seal remover 41-R-2384-38 to remove the inner and outer oil seals (figs. 55 and 80). To install the inner and outer oil seals, use the oil seal replacer

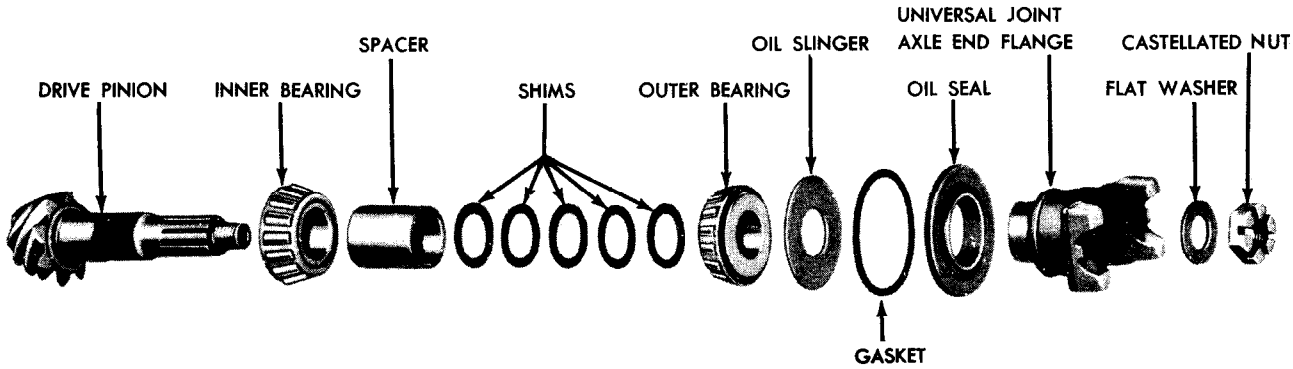


Figure 57 — Drive Pinion Assembly — Exploded View

## POWER TRAIN

41-R-2391-20 and tap the oil seals in the inner and outer ends of the axle housing (fig. 56). Using a brass hammer, tap the oil seal retainer in the outer end of the axle shaft housing.

(f) *Axle Housing Bushing Replacement (For Tracta Type Axle Shafts Only)*. Remove the bushing from the outer end of the axle housing, using a standard puller. To install a new bushing, place the bushing in position in the axle housing and using a suitable driver, drive the bushing in the housing until it is flush with the shoulder in the axle housing.

(2) **DRIVE PINION ASSEMBLY** (fig. 57). Roller bearings that are pitted, corroded or discolored due to overheating must be replaced. Replace the drive pinion if it has worn or broken teeth. The differential ring gear and the drive pinion assembly are furnished only in matched sets and if either is found damaged, both must be replaced. Small nicks can be removed from the pinion gear with a fine stone.

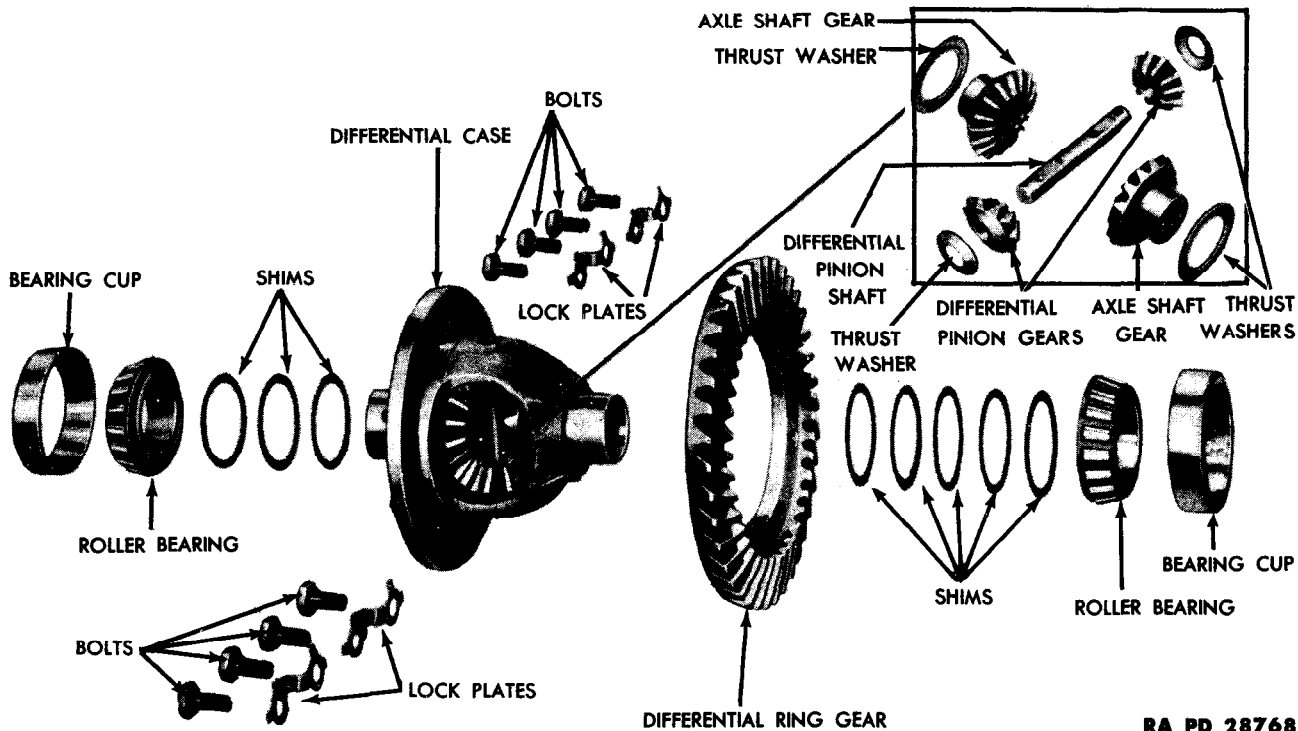
(3) **DIFFERENTIAL ASSEMBLY** (fig. 58). Replace any gear that is excessively worn or has any broken teeth. The differential ring gear and the drive pinion assembly are furnished only in matched sets and if either is found damaged, both must be replaced. Replace the differential pinion gears, if the inside diameter is worn to more than 0.627 inch. Replace the differential pinion shaft if the diameter is less than 0.623 inch. Replace the axle shaft gears if the outside diameter of the hub is worn to less than 1.498 inches. Replace the differential pinion gear and axle shaft gear thrust washers if the thickness is worn to less than 0.32 inch. Roller bearings and races that are pitted, corroded or discolored due to overheating must be replaced. All shims that were damaged during the disassembly must be replaced.

(4) **AXLE SHAFTS**. Three different types of axle shaft universal joints as shown in figures 38, 42, and 44 are used in front axles. Inspection of each of these three types is covered in steps (a), (b), and (c), below.

(a) *Rzeppa Universal Joint* (fig. 59). Replace the inner axle shaft if it is bent or has worn splines. Using a new axle shaft gear as a gage, slip it on the inner axle shaft and check the backlash. If the backlash is more than 0.005 inch, replace the axle shaft. Replace the outer axle shaft if it has worn splines or nicked ball bearing surfaces. Replace the inner race if it is found to be excessively worn. Small nicks or scratches can be removed with a fine stone. Replace steel balls that have flat spots. Replace the cage if it is cracked.

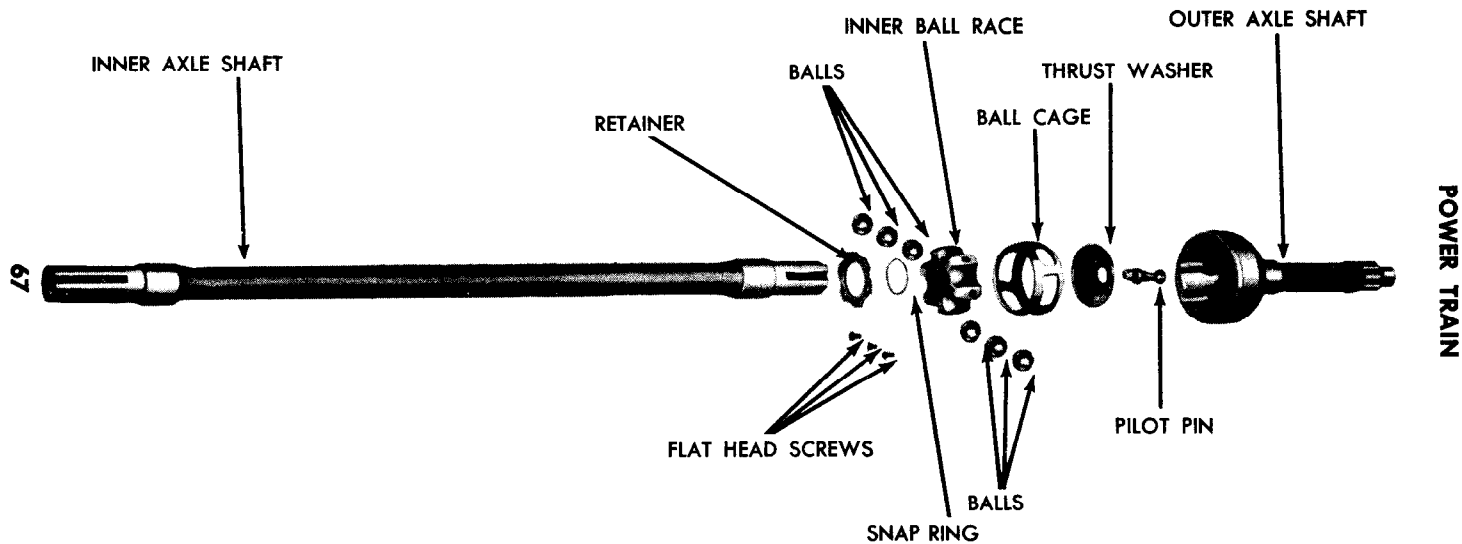
(b) *Bendix Universal Joint* (fig. 43). Replace the inner axle shaft if it is bent or has worn splines or worn universal joint ball surface. Replace the universal joint knuckle if it has worn splines or

66



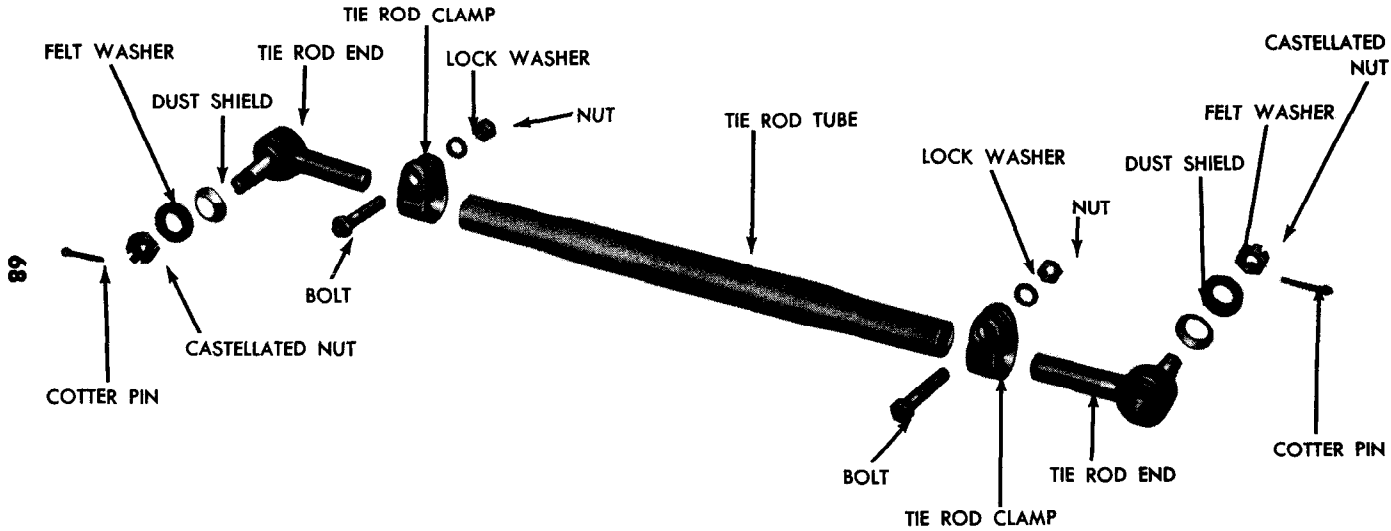
RA PD 28768

Figure 58 — Differential Assembly — Exploded View



RA PD 28769

Figure 59 — Axle Shaft — Exploded View (Rzeppa Type)



RA PD 28770

Figure 60 — Tie Rod, Right Side — Exploded View

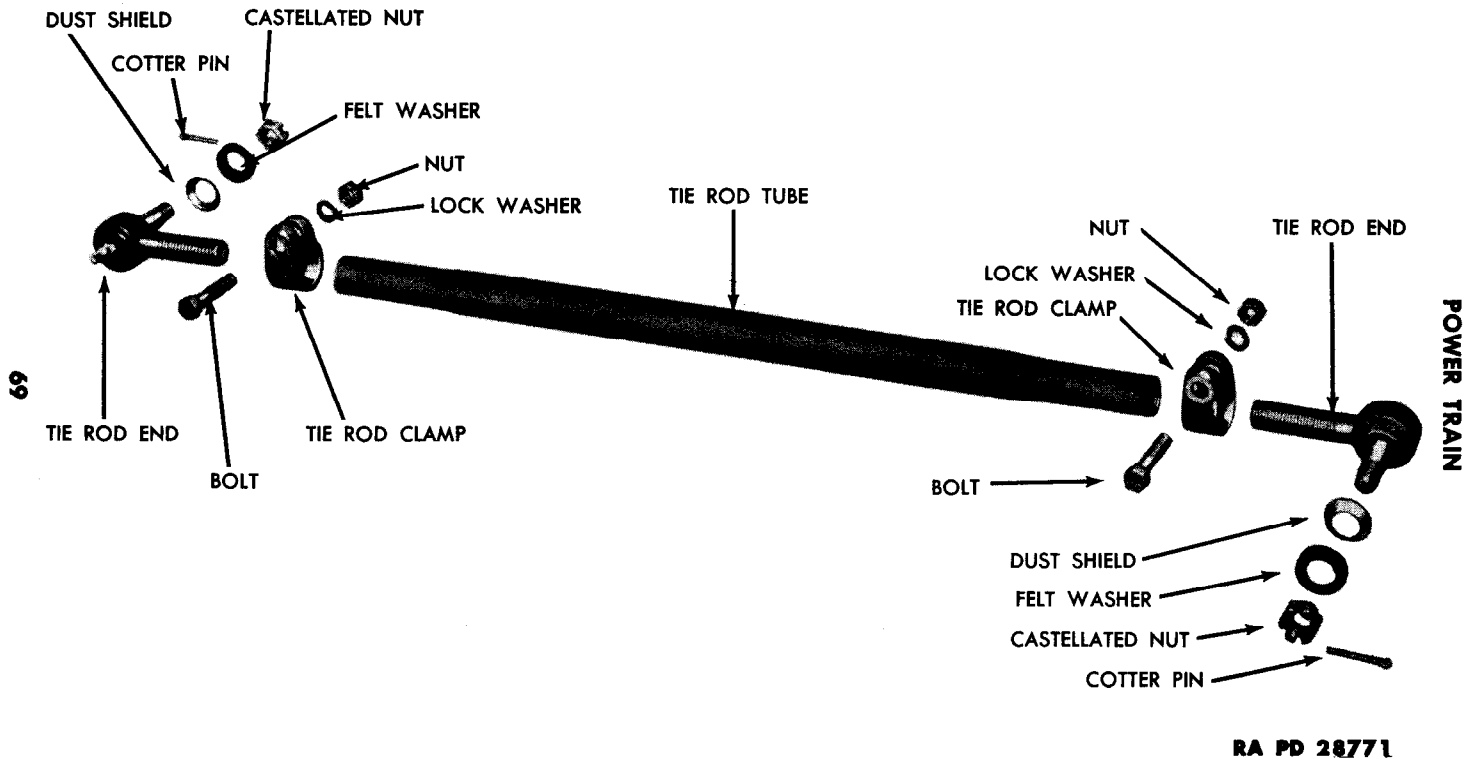
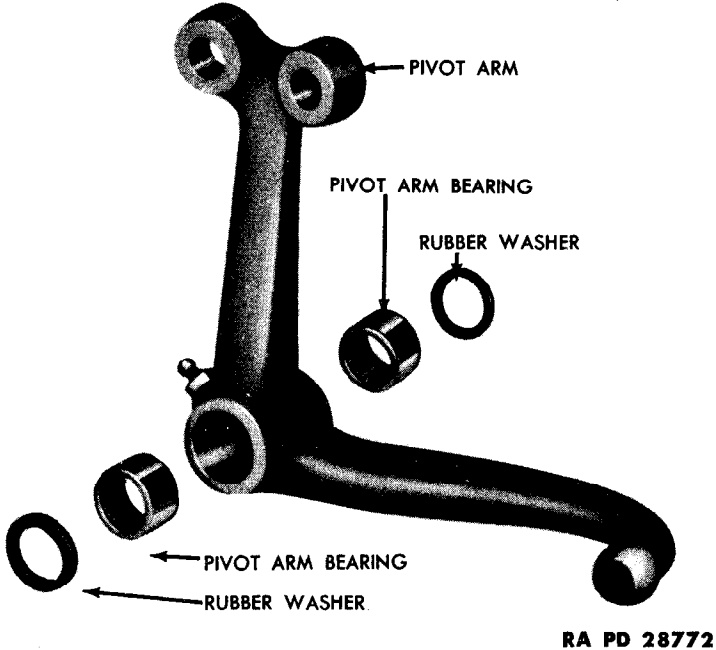


Figure 61 — Tie Rod, Left Side — Exploded View

ORDNANCE MAINTENANCE — POWER TRAIN, BODY, AND FRAME FOR ¼-TON 4x4 TRUCK  
(WILLYS-OVERLAND MODEL MB AND FORD MODEL GPW)



RA PD 28772

Figure 62 — Pivot Arm — Exploded View

worn ball surfaces. Small nicks or scratches can be removed with a fine stone. Replace universal joint balls, if they are excessively worn or have any flat spots.

(c) *Tracta Universal Joint* (fig. 45). Replace the inner portion or the outer portion of the axle shafts, if they are bent or have worn splines. Replace the inner portion or the outer portion of the universal joints, if they are cracked or excessively worn. Small nicks or scratches can be removed with a fine stone.

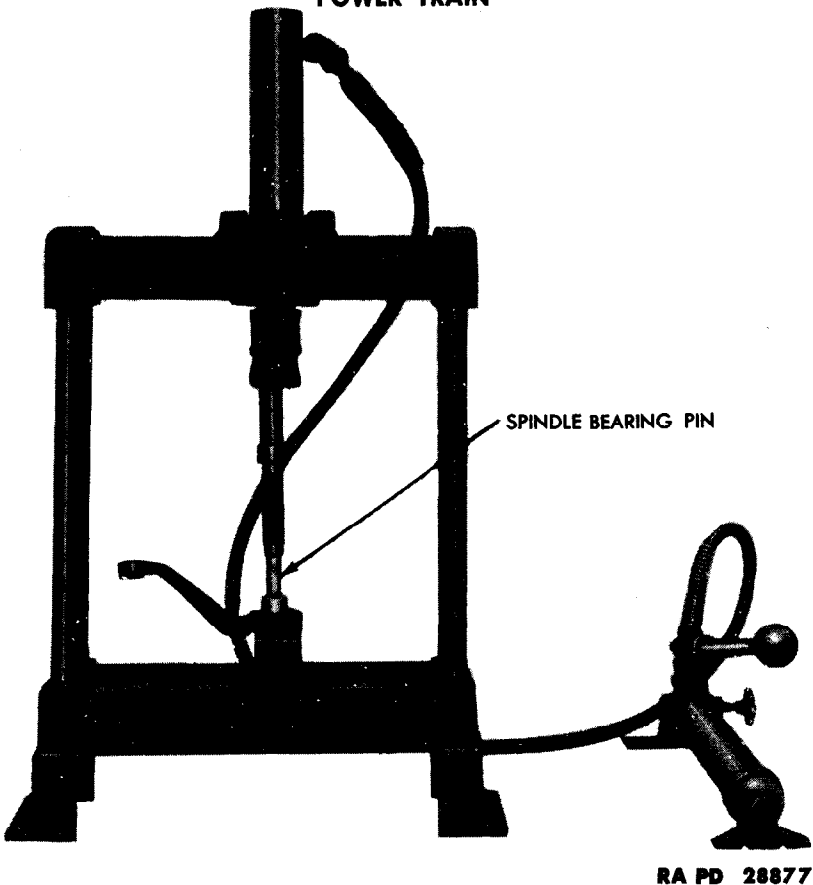
(5) TIE RODS AND PIVOT ARM (figs. 60, 61, and 62).

(a) *Inspection*. Replace the tie rods if bent or damaged. Replace the tie rod ends if the sockets are loose (step (b), below). Replace the pivot arm, if it is bent or has a worn ball joint. Replace the needle roller bearings in the pivot arm if they are loose or excessively worn (step (c), below).

(b) *Tie Rod End Replacement* (figs. 60 and 61). Loosen the tie rod clamps at both ends of the tie rod. Remove the tie rod ends from the tie rods. To install tie rod ends, place the tie rod clamps on the tie rod. Install the tie rod ends.

(c) *Pivot Arm Needle Bearing Replacement* (fig. 62). Place the pivot arm in a press and with a suitable driver, press out the two

POWER TRAIN



RA PD 28877

**Figure 63 — Replacing Spindle Bearing Pin in Spindle Arm**

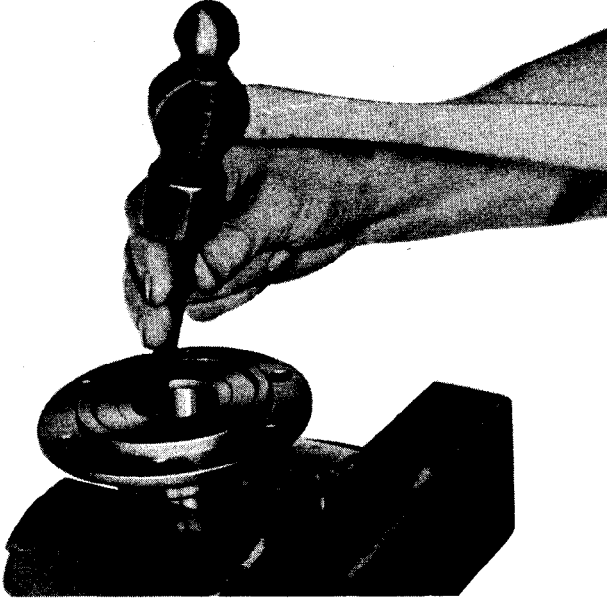
needle bearings. To install the needle bearings, press one needle bearing in the pivot arm about  $\frac{1}{16}$  inch below the shoulder of the pivot arm, then turn the pivot arm over and press the other bearing in the arm about  $\frac{1}{16}$  inch below the shoulder of the pivot arm.

**(6) SPINDLE ARM AND SPINDLE HOUSING BEARING CAP.**

*(a) Inspection.* Replace the spindle arm if bent. Replace the spindle arm bearing pin if the diameter of the pin is worn to less than 0.623 inch. Replace the spindle housing bearing cap pin if it is worn to less than 0.625 inch (step *(b)*, below).

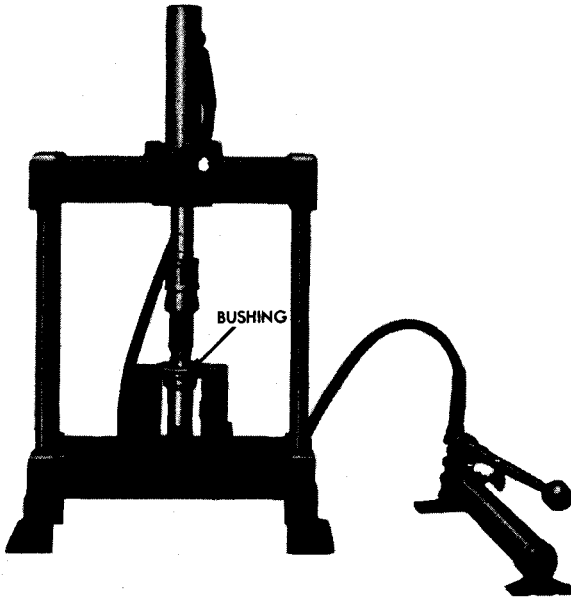
*(b) Spindle Bearing Pin Replacement.* Place the spindle housing bearing cap or the spindle arm (fig. 76) in a press and with a suitable driver, press out the bearing pin. To install a new pin, use a suitable driver and press the pin in until it is flush with the outer

ORDNANCE MAINTENANCE — POWER TRAIN, BODY, AND FRAME FOR ¼-TON 4x4 TRUCK  
(WILLYS-OVERLAND MODEL MB AND FORD MODEL GPW)



RA PD 28774

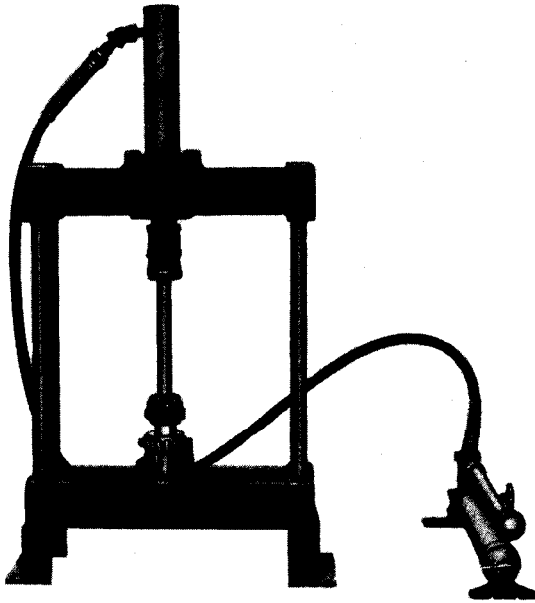
*Figure 64 — Removing Spindle Bushing*



RA PD 28773

*Figure 65 — Pressing New Bushing in Spindle*

POWER TRAIN



RA PD 28776

Figure 66 — Installing Inner Bearing on Pinion

shoulder. The same procedure applies to both the spindle housing bearing cap and the spindle arm (fig. 63).

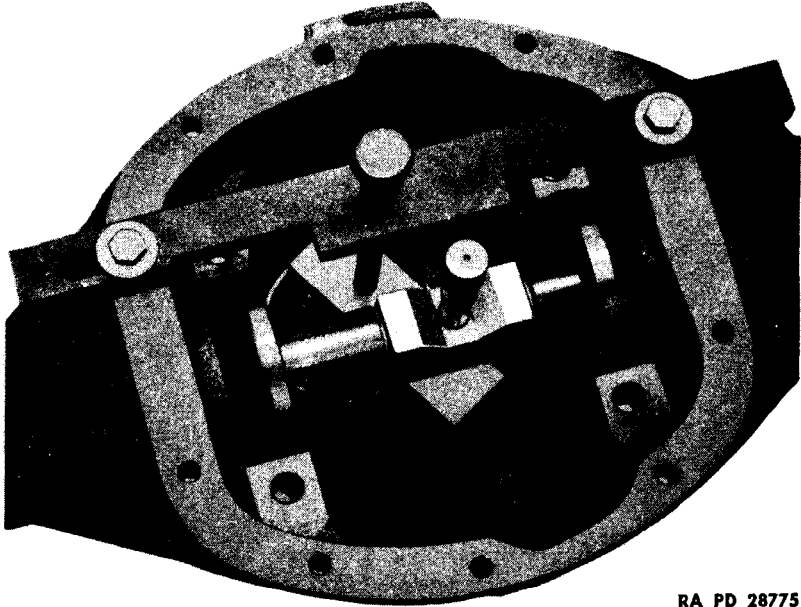
(7) SPINDLE HOUSING AND SPINDLE (fig. 76).

(a) *Inspection.* Replace the spindle housing if it is cracked. If the studs on the spindle housing are bent, broken or damaged, replace them (step (b), below). Replace the spindle, if it has damaged threads or grooved bearing surfaces. If the inner diameter of the spindle bushing is more than 1.225 inch, replace the bushing (subpar. (c), below).

(b) *Broken Stud Replacement.* Indent the end of the broken stud exactly in the center with a center punch. Drill approximately two-thirds through the broken stud, using a small drill, then follow up with a larger drill (the size of the drill depending on the size of the stud to be removed). The drill selected, however, must leave a wall thicker than the depth of the threads. Select an extractor of the proper size. Insert it into the drilled hole and screw out the remaining part of the broken stud. To install a new stud, use a standard stud driver and drive all studs until no threads show at the bottom of the stud. If the stud is too tight or too loose in the stud hole, select another stud.

(c) *Spindle Bushing Replacement.* The spindle bushing can be removed with a center punch as shown in figure 64. To install a

**ORDNANCE MAINTENANCE — POWER TRAIN, BODY, AND FRAME FOR ¼-TON 4 x 4 TRUCK  
(WILLYS-OVERLAND MODEL MB AND FORD MODEL GPW)**



RA PD 28775

**Figure 67 — Checking Pinion in Differential Housing With Gage  
41-G-176**

new bushing, use a suitable driver and press the bushing in the spindle (fig. 65).

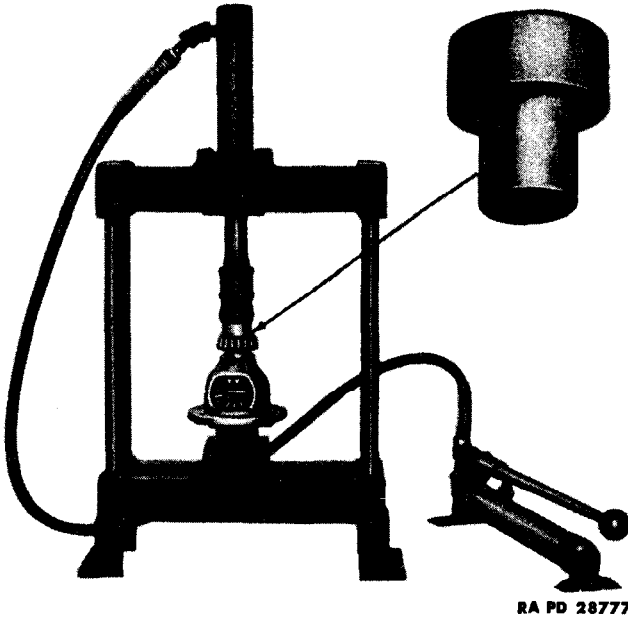
**26. ASSEMBLY.**

**a. Install Inner Bearing on Pinion (fig. 66).** Press the inner bearing on the pinion, using an arbor press. Make sure the bearing is seated against the shoulder of the pinion gear when installed.

**b. Adjust Pinion in Housing (fig. 67).** Place the pinion in the differential housing. Install the 41-G-176 gage to check the setting from the back face of the pinion to the center line of the differential case bearing. The standard setting is 0.719 inch. If the gage reading is more than 0.179 inch, shims will have to be added to the inner bearing cup (par. 25 b (1) (c)). If the gage reading is less than 0.719 inch, shims will have to be removed from the inner bearing cup (par. 25 b (1) (c)).

**c. Install Outer Bearing on Pinion (fig. 57).** After the correct pinion setting has been obtained, install the spacer and the original amount of shims on the pinion. If the thickness of the original shims is unknown, install the shims totaling approximately 0.060 inch thick

POWER TRAIN



**Figure 68 – Installing Differential Bearing, Using Special Replacer  
41-R-2391-65**

before installing the outer bearing. Start the outer bearing on the pinion. Install the oil slinger on the pinion.

**d. Adjust the Outer Bearing.** Place the universal joint flange on the pinion. Install the nut on the universal joint flange and draw the flange down tight. Turn the universal joint flange, if there is a slight drag, the pinion bearing adjustment is correct. If the pinion turns with difficulty or can't be turned by hand, shims will have to be added behind the outer bearing. If the pinion turns loosely, shims will have to be removed. If the pinion bearing adjustment is not correct, remove the universal joint flange, and add or remove shims until the correct adjustment is obtained. After the correct adjustment is obtained, again remove the universal joint flange and install the oil seal on the pinion. Install the universal joint flange. Install the nut and cotter pin.

**e. Install Gears in Differential Case (fig. 58).** Place the axle shaft gear thrust washers on the two axle shaft gears. Place the axle shaft gears in the case. Place the two differential pinion thrust washers and gears in the case. Install the differential pinion gear shaft in the case. Install the pinion shaft lock pin in the case and stake the pinion shaft lock pin to prevent the pin from coming out.

ORDNANCE MAINTENANCE — POWER TRAIN, BODY, AND FRAME FOR ¼-TON 4x4 TRUCK  
(WILLYS-OVERLAND MODEL MB AND FORD MODEL GPW)

**Figure 69—Checking Clearance Between Differential Case and Bearing**

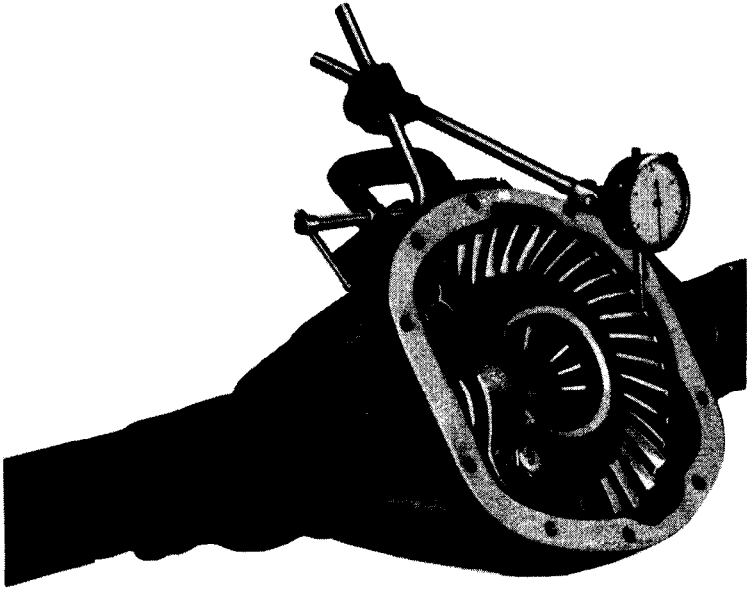
f. **Install Differential Ring Gear** (fig. 58). Place the differential ring gear in position on the case. Install the lock plates and cap screws that secure the ring gear to the case. Bend the ears of the lock plates on the cap screws.

g. **Install Roller Bearings on Case** (fig. 68). If all the original parts have been used in the differential assembly, add the same thickness of shims as originally used and press the roller bearings on the case, then proceed with subparagraph h, below. If the original parts are not being used, or if the original shim thickness is not known, install the roller bearings on the case without the shims, and proceed with subparagraph i, below.

h. **Install Differential Assembly in Housing** (fig. 47). Place the bearing cups on the roller bearings. Tilt the bearing cups in order to start the assembly in the housing. Tap the bearing cups lightly until the assembly is seated firmly in the housing. Install the two bearing caps so the numbers on the caps and the housing face the same way and match in every way as shown in figure 47. If the differential assembly being used is not the one originally in the axle, proceed with subparagraph i, below.

i. **Adjust Differential Assembly** (fig. 69). Place the bearing cups on the differential assembly and place the assembly in the housing.

POWER TRAIN



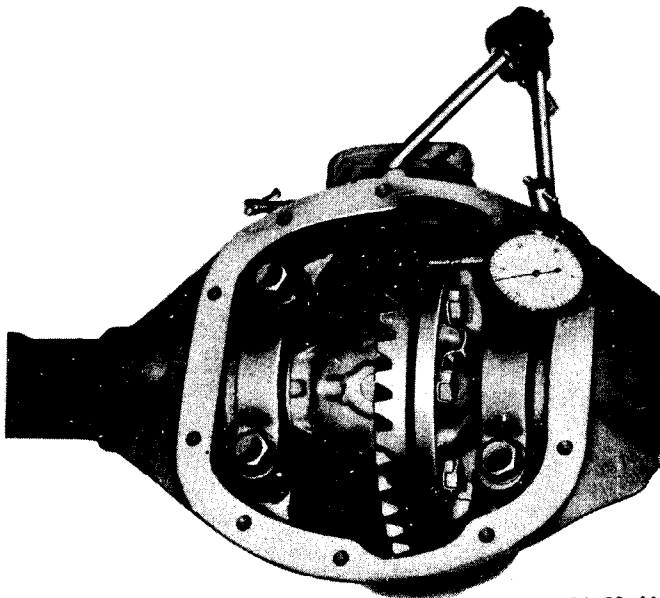
RA PD 28780

**Figure 70 — Checking Ring Gear Backlash With Dial Indicator 41-I-100**

Slide the assembly to one side of the housing. Check the clearance between the bearing cup and differential housing with a feeler gage. After this clearance has been determined, add 0.008 inch. This will give the thickness of shims required for proper bearing adjustment. Remove the differential assembly from the housing. Remove the bearings from the differential case (par. 24 f (3)). Install the amount of shims determined above in equal amounts on each side of the case and install the bearings back on the case (subpar. g, above). Tilt the bearing cups and place the differential in the housing. Tap the bearing cups lightly until the assembly is seated firmly in the housing. Install the two bearing caps so the numbers on the caps and the housing face the same way, and match in every way.

**j. Check Backlash** (fig. 70). Install a dial indicator 41-I-100 on the differential housing so that the indicator contact is resting on the surface of a ring gear tooth as shown in figure 70. Rotate the ring gear back and forth to determine the backlash. If the backlash is less than 0.005 inch or more than 0.007 inch, remove the differential from the housing (par. 24 e) and remove the bearings from the differential case (par. 24 f (3)). If the backlash was more than 0.007 inch, the ring gear must be brought closer to the pinion. If the backlash was less than 0.005 inch, the ring gear must be moved away from the pinion. This is accomplished by moving shims equal to the

ORDNANCE MAINTENANCE — POWER TRAIN, BODY, AND FRAME FOR ½-TON 4 x 4 TRUCK  
(WILLYS-OVERLAND MODEL MB AND FORD MODEL GPW)



RA PD 28779

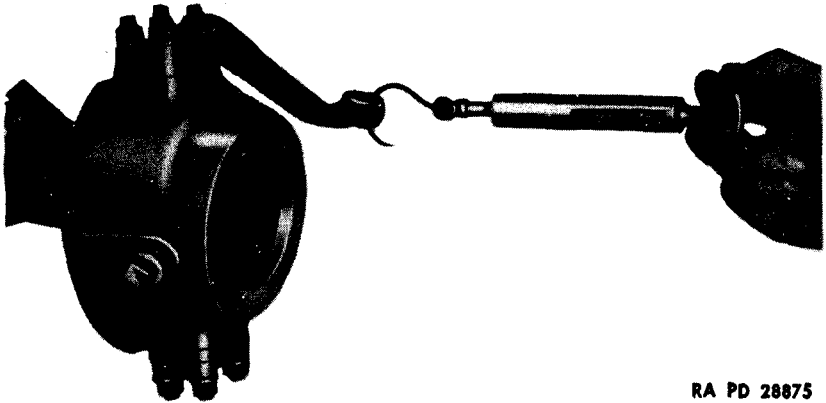
**Figure 71 —Checking Ring Gear Run-out With Dial Indicator 41-I-100**

error in backlash from one side of the case and adding them to the other side. Install the bearings on the case (subpar. g, above). Install differential in housing (subpar. h, above) and recheck the backlash.

**k. Check Ring Gear Run-out (fig. 71).** Install a dial indicator on the differential housing so that the indicator contact is resting on the flat side of the ring gear as shown in figure 71. Turn the pinion drive flange by hand to determine the run-out on the ring gear. The run-out should not exceed 0.003 inch. If the run-out is more than 0.003 inch, remove the differential assembly from the housing (par. 24 e), and remove the ring gear from the differential case. Check the surface of the differential case and the ring gear for chips or small nicks, which might have occurred during the assembly of the differential. If any small nicks are found, remove them with a fine stone, also check the flange on the differential case for being sprung. Reinstall the differential assembly in the housing (subpar. h, above) and recheck the ring gear run-out.

**l. Install Differential Cover (fig. 46).** Place a new gasket and the differential cover in place on the axle housing. Install the 10 cap screws that secure the cover to the housing.

POWER TRAIN



RA PD 28875

*Figure 72 — Checking Tension of Spindle Housing*

m. **Install Pivot Arm (fig. 46).** Insert the two rubber seals in the pivot arm. Place the flat washer on the pivot arm shaft. Place the pivot arm on the shaft with the ball joint of the arm facing downward. Place the flat washer and dust shield on the shaft. Install the castellated nut and cotter pin.

n. **Install Spindle Housing (fig. 76).** Dip the two spindle housing bearings in grease. Place the bearings in the bearing cups on the axle housing. Place the spindle housing on the axle housing with the grease plug to the rear of the vehicle. Install shims totaling 0.048 inch thick on the spindle bearing cap and the spindle arm. Shims are available in thicknesses of 0.003 inch, 0.005 inch, 0.010 inch and 0.030 inch. Install one of each size on the top and bottom of the spindle housing. Place the lower bearing cap on the spindle housing and install the four nuts that secure the cap to the spindle housing. Place the spindle arm on the spindle housing and install the four nuts that secure the spindle arm to the spindle housing.

o. **Adjust Spindle Housing (fig. 72).** Check the tension of the spindle housing by hooking a scale to the end of the spindle arm. The tension should not be more than 6 pounds or less than 4 pounds. If the tension is over 6 pounds, shims must be removed from the spindle housing. If the tension is less than 4 pounds, shims must be added. When removing or adding shims, be sure the same thickness is removed from, or added to, both ends of the spindle housing. Remove, or add, shims until the correct tension is obtained.

p. **Install Spindle Housing Oil Seal (fig. 76).** Place a new gasket on the spindle housing. Place the upper and lower halves of the oil seal on the spindle housing. Install the four cap screws that secure the lower half of the oil seal to the spindle housing. Place the axle

**ORDNANCE MAINTENANCE — POWER TRAIN, BODY, AND FRAME FOR ¼-TON 4 x 4 TRUCK  
(WILLYS-OVERLAND MODEL MB AND FORD MODEL GPW)**

shaft identification tag on the upper half of the oil seal. Install the four cap screws that secure the upper half of the oil seal to the spindle housing.

**q. Assemble Axle Shafts.** Three different types of front axle universal joints (figs. 38, 42, and 44) are used. Assembly procedures for the Rzeppa and Bendix types are covered in subparagraphs (1) and (2), below. The Tracta type front axle universal joint (fig. 43) requires no assembly before installation (subpar. r (2), below).

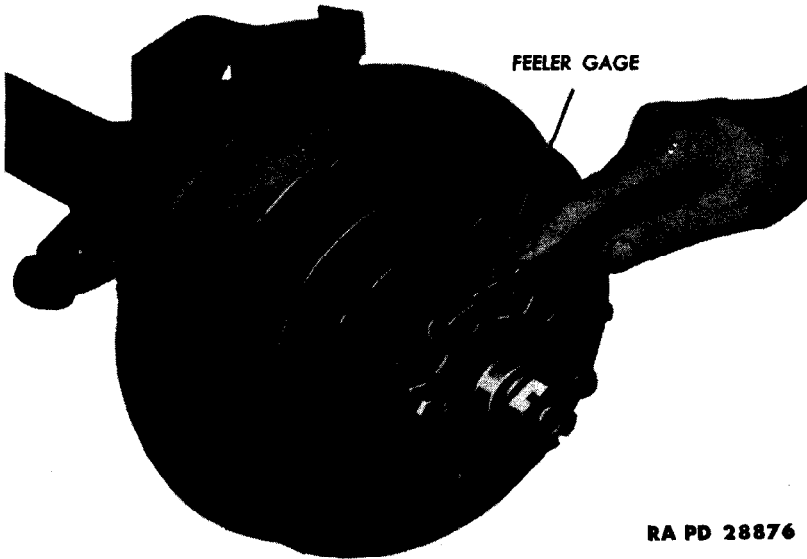
(1) **RZEPPA JOINT** (fig. 38). Hold the cage in a horizontal position and hold the inner race in a vertical position (fig. 41). Insert the inner race in the cage, dropping one of the inner race bosses into one of the larger elongated holes. When the race is entered in the cage, turn the race so that it is entirely in the cage. Line up the two larger elongated holes with the bosses on the axle shaft (fig. 40). Slide the cage in the axle shaft. Holding the cage in this position, insert the thrust washer (fig. 59) behind the cage. Tilt the cage so that it is flush with the shaft. Tilt the cage so that a steel ball can be inserted in the elongated hole (fig. 39). After the steel ball is in position, push the cage down until the opposite side of the cage is exposed. Insert another steel ball in the elongated hole on the cage and push the cage down. Repeat this operation until all the steel balls are in the cage. Insert the pilot pin (fig. 59) in position. Insert the retainer on the axle shaft and secure the retainer with the snap ring. Insert the inner shaft in the outer shaft. Install the three flat head screws that secure the retainer to the inner race.

(2) **BENDIX JOINT** (figs. 42 and 43). Place the universal joint knuckle in an upright position in a vise. Insert the center ball in the hole of the knuckle. Place the center ball in its race on the center ball pin hole. Arrange the center ball so that the grooved side of the center ball is away from the pin hole. Insert the three universal joint balls in their races. Arrange the center ball so that the grooved side is in line with the race of the last ball to be installed as shown in figure 42 and drop the ball in its race. Rotate the center ball in its race until the hole in the ball is in line with the center ball pin. Remove the assembly from the vise. Turn the assembly over so that the pin may drop in the hole of the center ball. Install the grooved pin in the knuckle and stake the pin to prevent it from coming out.

**r. Install Axle Shaft.**

(1) **BENDIX AND RZEPPA JOINTS.** Slide the axle shaft in the axle housing. It will be necessary to turn the axle shaft until the splines on the axle shaft are in line with the axle shaft gear in the differential.

POWER TRAIN



RA PD 28876

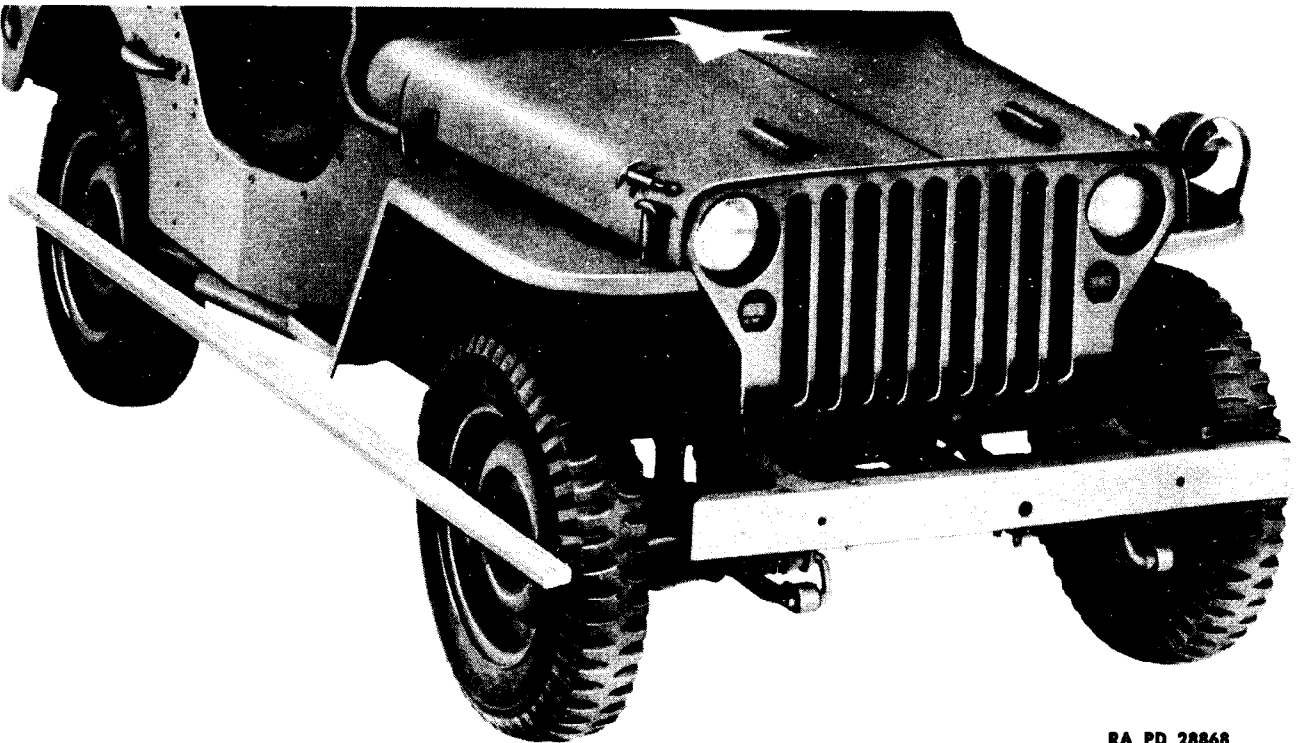
**Figure 73 – Checking Clearance Between Drive Flange and Hub**

(2) **TRACTA JOINT** (fig. 45). Slide the inner portion of the axle shaft and the inner portion of the universal joint into the axle housing. Turn the axle shaft so as to line up the splines of the axle shaft with the axle shaft gear in the differential. Slide the outer portion of the universal joint on the outer portion of the axle shaft. Line up the slots of the two universal joints and slide the outer axle shaft in place on the axle.

s. **Install Brake Plate and Spindle.** Place the spindle on the spindle housing. Place the brake plate on the spindle with the wheel cylinder toward the top of the brake plate. Line up the holes in the brake plate and spindle with the spindle housing. Install the six cap screws that secure them to the spindle housing.

t. **Install Hydraulic Brake Hose** (fig. 46). Install the brake hose to the brake line on the axle housing. Install the clamp to the brake hose at the bracket on the axle housing. Insert the brake hose through the guard and connect the hose to the brake line on the brake plate. Install the brake hose clamp at the guard.

u. **Install Hub and Brake Drum** (fig. 46). Pack the wheel bearings with the specified lubricant. Insert the hub and brake drum on the spindle with the inner wheel bearing and grease retainer in the hub. Insert the smaller thrust washer on the spindle and install the bearing adjusting nut. Tighten the adjusting nut until the brake



RA PD 28868

*Figure 74 — Checking Wheels With Straightedge*

## POWER TRAIN

drum binds when turned; then back off the adjusting nut one-eighth turn. This will give the correct wheel bearing adjustment. Install the lock washer and lock nut on the spindle. Bend the ears of the lock washer over the lock nut.

### v. Install Drive Flange (fig. 73).

(1) **RZEPPA TYPE AXLE SHAFTS.** Install a 0.060-inch thickness of shims between the drive flange and the hub. Place the drive flange on the axle shaft. Install the six cap screws that secure the drive flange to the hub. Install the castellated nut on the axle shaft. Install the hub cap on the drive flange.

(2) **BENDIX OR TRACTA TYPE AXLE SHAFT (fig. 73).** Place the drive flange on the axle shaft. Install the castellated nut on the axle shaft and draw it down tight. Turn the front wheels to the maximum left or right and measure the space between the drive flange and hub with a feeler gage (fig. 73) to determine the number of shims to be installed. Remove the nut from the axle shaft and remove the drive flange. Add the required thickness of shims between the drive flange and the hub. Install the six cap screws that secure the drive flange to the hub. Install the castellated nut on the axle shaft. Back off the nut on the axle shaft until a 0.50-inch feeler gage can pass between the nut and drive flange. Tap the nut on the axle shaft lightly. The axle shaft will move inward. Again check the space between the nut and drive flange. The space should not be less than 0.015 inch or more than 0.035 inch. If the space is less than 0.015 inch, add shims behind the drive flange and hub until this limit is obtained. If the space is more than 0.035 inch, remove shims from the drive flange until the above limit is obtained. Draw the nut on the axle shaft up tight. Install the hub cap.

w **Install Tie Rods (fig. 46).** Insert the ends of the tie rods in the spindle arms and pivot arm. Be sure the dust shield and felt washer are on the tie rod ends. Install the castellated nuts that secure the tie rod ends to the spindle arms and to the pivot arm.

## 27. INSTALLATION.

a. **Preliminary Work.** Place a hydraulic jack under the front axle assembly. Roll the assembly under the vehicle. Raise the assembly until the front springs can be raised and secure to the spring shackles. Lower the jack to allow the axle assembly to rest on the springs.

b. **Install Spring U-bolts (fig. 35).** Place the spring U-bolts in position on the axle housing. Install the spring seat plate on the U-bolts at the right side of the axle. Install the four nuts that secure the spring seat to the U-bolts. Raise the torque reaction spring in position on the U-bolts on the left side. Install the nuts that secure the torque reaction spring to the U-bolts.

ORDNANCE MAINTENANCE — POWER TRAIN, BODY, AND FRAME FOR ¼-TON 4x4 TRUCK  
(WILLYS-OVERLAND MODEL MB AND FORD MODEL GPW)

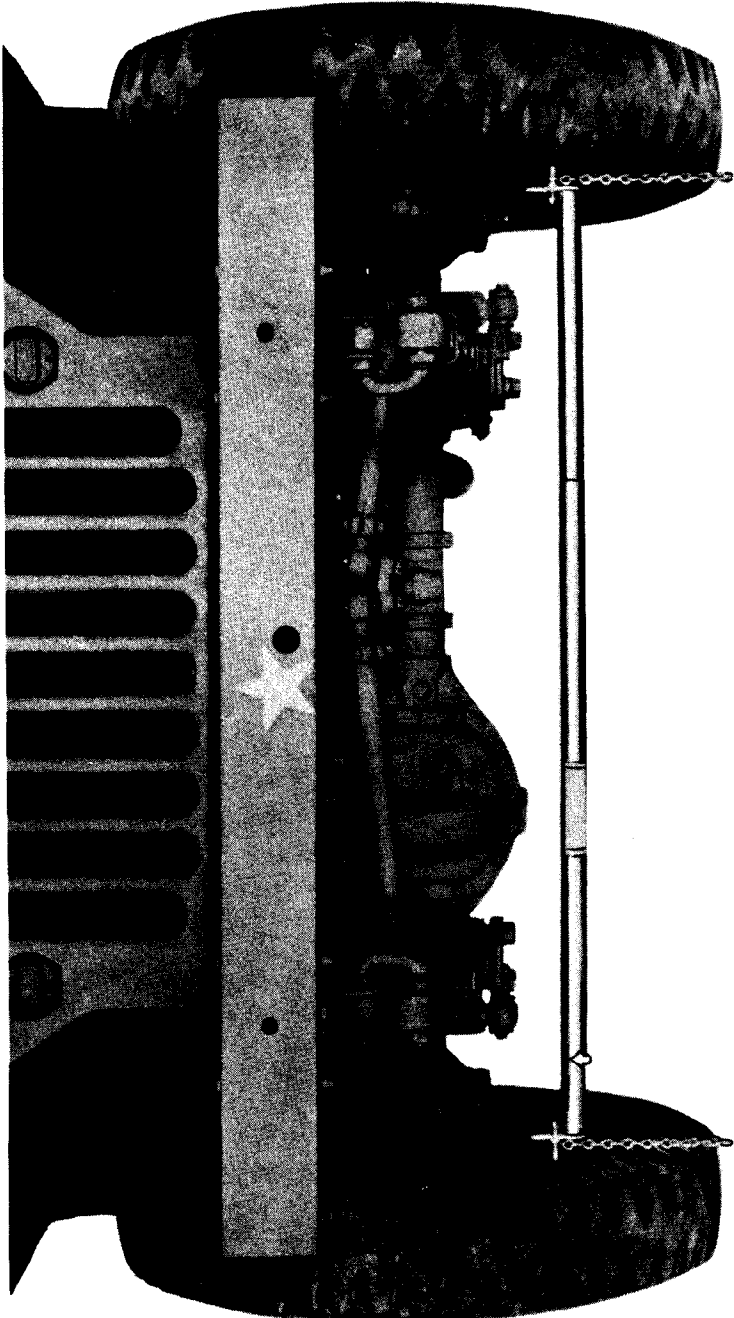
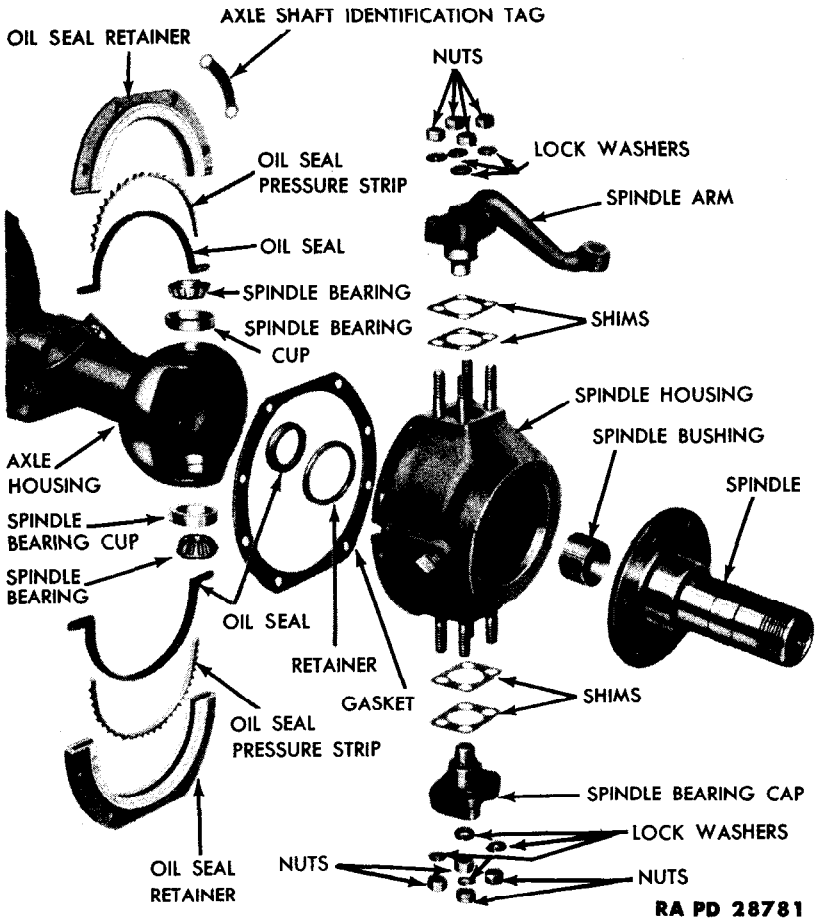


Figure 75 — Adjusting Toe-in, Using Wheel Alining Gage 41-G-510  
RA PD 28869

**POWER TRAIN**



RA PD 28781

**Figure 76 – Spindle Housing – Exploded View**

c. **Install Shock Absorbers (fig. 35).** Insert a rubber mounting in each side of each shock absorber eye. Place the shock absorber on the mounting bracket at the spring seat plate. If new rubber mountings are being used, compress them with compressor 41-C-2554-400. Install the flat washer and cotter pin that secure the shock absorber to the spring seat plate. Place the left shock absorber on the mounting bracket at the torque reaction spring. Install the flat washer and cotter pin that secure the shock absorber to the torque reaction spring.

d. **Install Propeller Shaft, Drag Link, and Wheels (fig. 35).** Install the propeller shaft to the front axle (par. 21 b). Place the drag link in the ball joint on the pivot arm. Install the drag link

**TM 9-1803B**  
**27-29**

**ORDNANCE MAINTENANCE — POWER TRAIN, BODY, AND FRAME FOR ¼-TON 4x4 TRUCK  
(WILLYS-OVERLAND MODEL MB AND FORD MODEL GPW)**

plug on the drag link. Install the cotter pin in the drag link plug. Install the wheels.

e. **Lubricate.** Fill the differential to proper level with specified oil. Apply specified grease in each spindle housing and to all fittings. Bleed the hydraulic brake system. Refer to TM 9-803.

**28. WHEEL ALINEMENT.**

a. **Caster and Camber.** The caster and camber is established at the time of manufacture and cannot be altered by any adjustment.

**b. Toe-in.**

(1) **EQUALIZE TIE RODS** (fig. 74). Set the pivot arm parallel to the axle and place a straightedge against the left rear and left front wheel. If the rear or front sides of the front tire do not touch the straightedge, the tie rods must be adjusted. Loosen the tie rod clamps at both ends of the left tie rod. Turn the tie rod tube clockwise to bring the forward side of the front wheel inward, or counterclockwise to bring the rear side of the front wheel inward. Adjust until the straightedge touches the side of the front tire at both front and rear. Repeat this procedure on the right-hand side of the vehicle.

(2) **ADJUST TOE-IN** (fig. 75). After the tie rods have been equalized, pull the vehicle forward at least three feet to remove the backlash and place the telescoping wheel alining gage 41-G-510 between the wheels in front of the axle so that the chains on both ends of the gage are barely touching the floor. Set the scale so the pointer registers zero. Pull the vehicle forward until the gage is brought to a position back of the axle with both chains barely touching the floor. The reading at this point will be the amount of toe-in or toe-out. Adjust the right-hand tie rod until a toe-in of  $\frac{1}{16}$  inch is obtained. Recheck the toe-in after making the adjustment. Tighten the tie rod clamps.

---

**Section VI**

**REAR AXLE**

**29. DESCRIPTION AND DATA.**

a. **Description** (fig. 78). The rear axle is the full-floating type, designed so that the axle shafts can be removed without disturbing the wheels. The differential drive is of the hypoid type. The differential parts are identical and are interchangeable with the front axle.

## POWER TRAIN

### b. Data.

#### Rear Axle:

Type ..... Full-floating  
Make ..... Spicer  
Drive ..... Through springs  
Road clearance .....  $8\frac{7}{8}$  in.

#### Differential:

Type ..... Hypoid  
Ratio ..... 4.88 to 1  
Bearings ..... Timken roller  
Oil capacity (pt) ..... 2.5

#### Pinion Shaft:

Bearings ..... Timken  
Adjustment ..... Shims  
Backlash ..... 0.005 to 0.007 in.

## 30. REMOVAL.

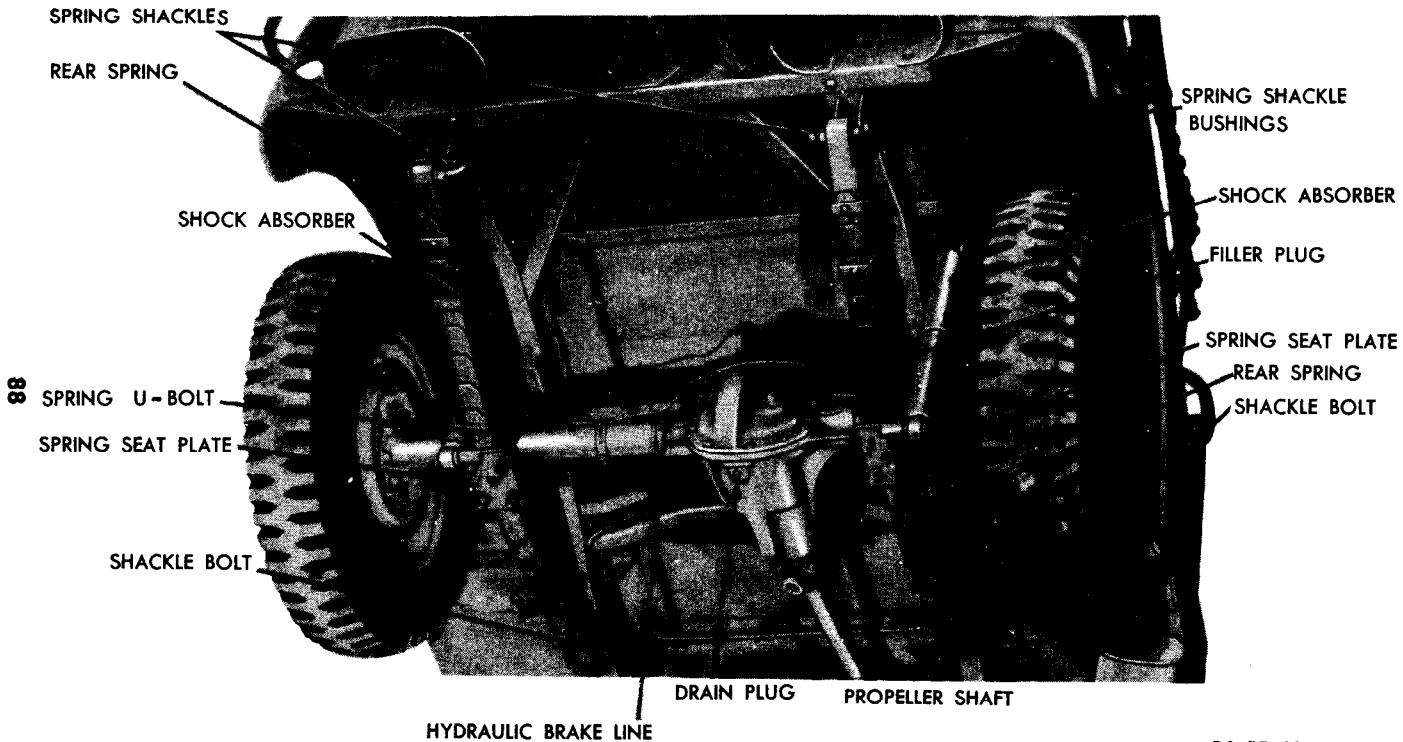
a. **Preliminary Work.** Remove the differential drain plug and drain the oil. Raise the rear of the vehicle until the weight of the vehicle is off the rear springs.

b. **Disconnect Propeller Shaft (fig. 77).** Remove the four nuts and two U-bolts that secure the propeller shaft to the universal joint flange at the rear axle. Slide the propeller shaft off the universal joint flange. Wrap a piece of tape around the bearings on the propeller shaft to prevent losing the bearings.

c. **Disconnect Shock Absorbers and Hydraulic Brake Line (fig. 77).** Remove the cotter pin and flat washer that secure the two rear shock absorbers to the bracket on the spring seat plates. Pull the shock absorbers off the bracket. Disconnect the hydraulic brake line leading to the rear axle at the differential housing.

d. **Remove Spring U-bolts (fig. 77).** Remove the four nuts that secure the spring U-bolts at both rear springs. Remove the U-bolts and the spring seat plates from the axle.

e. **Disconnect Springs (fig. 77).** Remove the lower spring shackle bushings at the rear of both springs. Pull both springs off the spring shackles. Drop the springs to the floor and roll the rear axle assembly out from the vehicle.



RA PD 329206

Figure 77 — Rear Axle Assembly in Vehicle

## POWER TRAIN

### 31. DISASSEMBLY.

a. **Remove Wheels.** Remove the five nuts that secure each wheel to the hub. Remove the wheels.

b. **Remove Axle Shafts (fig. 82).** Remove the six cap screws that secure the drive flange to the hub. Install two of the cap screws that were removed from the drive flange in the two threaded holes on the drive flange. Draw the cap screws down until the drive flange is free from the hub. Remove the axle shafts from the axle housing.

c. **Remove Hub and Drum Assembly (fig. 82).** Bend the ears of the flat washer off the bearing lock nut. Remove the bearing lock nut and bearing adjusting nut off the housing, using the wrench furnished with the vehicle. Slide the hub and drum assembly with the wheel bearings off the housing.

d. **Remove Brake Plate (fig. 82).** Disconnect the hydraulic brake line at the brake plate. Remove the six cap screws that secure the brake plate to the axle housing. Remove the brake plate from the axle housing.

e. **Remove Differential Assembly.** Remove the 10 cap screws that secure the differential cover to the housing (fig. 78). Remove the differential cover. Remove the 4 cap screws from the 2 differential bearing caps (fig. 47), and remove the caps. Remove the differential assembly from the housing, using a pry bar if necessary. Reinstall the bearing caps in the housing, noting the markings (fig. 47) to assure their being installed in their correct location.

f. **Remove Differential Pinion Gears and Axle Shaft Gears From Differential (fig. 48).** Place the differential assembly in a vise equipped with brass jaws. With a long-nosed drift, drive the differential pinion shaft tapered pin out of the differential gear case (fig. 48). Tap the differential pinion shaft from the case with a brass drift and hammer. Remove the two differential pinion gears and thrust washers and the two axle shaft gears and thrust washers from the case.

g. **Remove Ring Gear From Case (fig. 58).** Bend the ears of the lock plates off the cap screws. Remove the cap screws that secure the ring gear to the case, and remove the ring gear.

h. **Remove Roller Bearings From Differential Case (fig. 49).** Place the differential case in a vise. Install the bearing remover 41-R-2378-30 to the roller bearing. Remove the roller bearings from both ends of the differential case. Remove the shims. Note the thickness of the shims removed from each side to assist in reassembly.

i. **Remove Drive Pinion.** Remove the nut and flat washer that secure the universal joint axle end flange to the drive pinion. Install

RA PD 28867

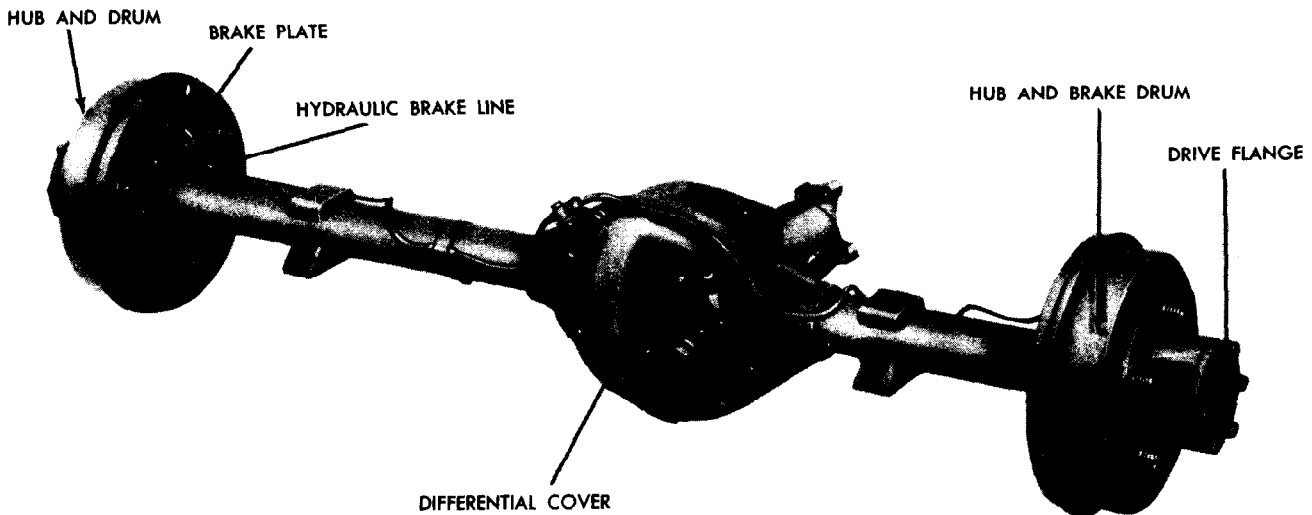


Figure 78 — Rear Axle Assembly

POWER TRAIN

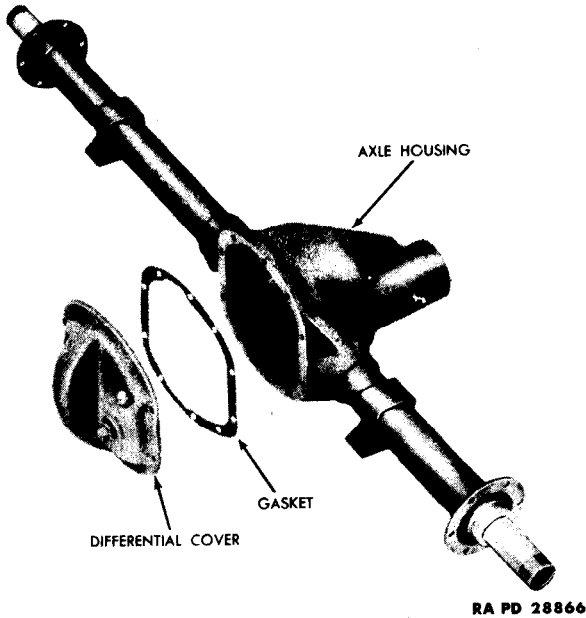


Figure 79 - Rear Axle Housing

the flange puller to the universal joint flange (fig. 50) and remove the flange. Using a brass drift and hammer, drive the drive pinion out of the axle housing (fig. 51). Remove the shims and spacer from the drive pinion. Note the thickness of shims removed from the pinion to assist in reassembly.

### 32. CLEANING, INSPECTION AND REPAIR.

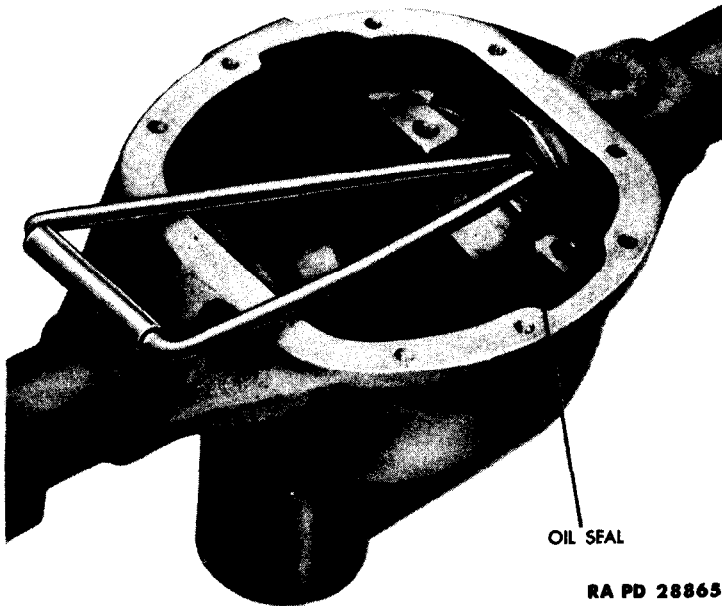
a. **Cleaning.** Clean all parts in dry-cleaning solvent. Rotate the bearings in dry-cleaning solvent until all trace of lubricant has been removed. Oil the bearings immediately to prevent corrosion of the highly polished surface.

#### b. Inspection and Repair.

(1) **AXLE HOUSING AND COVER** (fig. 79).

(a) *Inspection.* Replace the axle housing if it is broken at any of the welds or if it is cracked or bent. Replace the drive pinion bearing cups if they are pitted, corroded, or discolored due to overheating (subpar. (b), below). Replace the oil seals in the axle housing regardless of their condition (step (c), below). Replace the differential cover if cracked or if it has damaged threads in the filler plug hole. Replace the breather cap on the cover, if it is missing or damaged.

ORDNANCE MAINTENANCE — POWER TRAIN, BODY, AND FRAME FOR ¼-TON 4 x 4 TRUCK  
(WILLYS-OVERLAND MODEL MB AND FORD MODEL GPW)



**Figure 80 — Removing Oil Seal From Axle Housing, With Remover 41-R-2384-38**

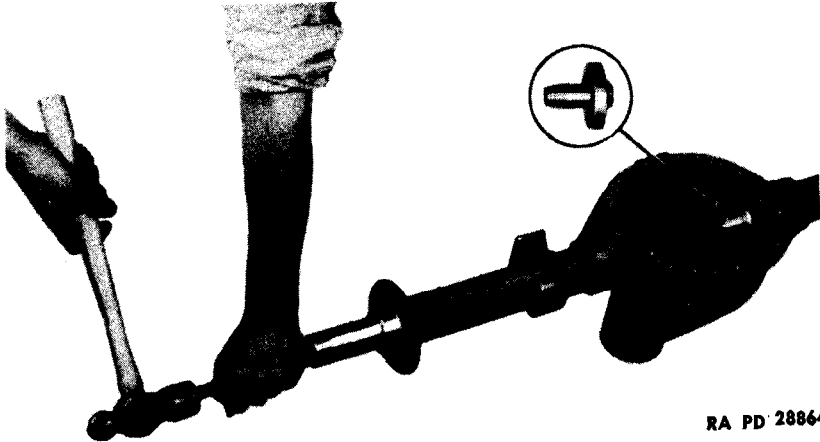
(b) *Drive Pinion Bearing Cap Replacement.* Remove the inner and outer bearing cups, using a standard puller. To assist in assembly, note the thickness of shims when removing the inner bearing cup. To install a new bearing cup, use a brass drift and hammer. Place the original thickness of shims behind the inner bearing cup and tap the bearing cup lightly around the entire circumference of the cup until it is flush with the shoulder in the axle housing (fig. 52).

(c) *Oil Seal Replacement* (fig. 80). Remove the inner oil seal with the remover 41-R-2384-38. To install a new oil seal, use special replacer 41-R-2391-20 and tap the oil seals in place (fig. 81).

(2) **DRIVE PINION ASSEMBLY** (fig. 57). Replace any roller bearings that are pitted, corroded, or discolored due to overheating. Replace the drive pinion gear if it has excessively worn, or broken teeth, or if the splines are worn or the threads damaged. The differential gear and the drive pinion are furnished in matched sets only, and if either is found damaged, both must be replaced. Small nicks can be removed from the pinion gear with a fine stone.

(3) **DIFFERENTIAL ASSEMBLY** (fig. 58). Replace any gears that are excessively worn or have any missing teeth. The differential ring gear and the drive pinion are furnished in matched sets only, and if

POWER TRAIN



RA PD 28864

**Figure 81 — Installing Oil Seal With Replacer 41-R-2391-20**

either is found damaged, both must be replaced. Replace the differential pinion gear if its inside diameter is more than 0.625 inch. Replace the differential pinion shaft, if the inside diameter is worn to less than 0.625 inch. Replace the axle shaft gear if the hub is worn to less than 1.500 inches. Replace the differential pinion gear and the axle shaft gear thrust washer if the thickness is worn to less than 0.032 inch. Roller bearings and cups that are pitted, corroded, or discolored due to overheating must be replaced.

(4) **AXLE SHAFT** (fig. 82). Replace the axle shafts if they are bent or have any worn or broken splines.

**33. ASSEMBLY.**

**a. Install Inner Bearing on Pinion** (fig. 66). Press the inner bearing on the pinion, using an arbor press. Make sure the bearing is firmly seated on the shoulder of the pinion gear when installed.

**b. Adjust Pinion in Housing** (fig. 67). Place the pinion in the differential housing. Install the gage 41-G-176 to check the setting from the back face of the pinion to the center line of the differential case bearing. The standard setting is 0.719 inch. If the gage reading is more than 0.719 inch, shims will have to be added to the inner bearing cup (par. 32 b). If the reading is less than 0.719 inch, shims will have to be removed from the inner bearing cup (par. 32 b).

**c. Install Outer Bearing on Pinion** (fig. 57). After the correct pinion setting has been obtained, install the spacer and the original amount of shims on the pinion. If the thickness of the original shims is unknown, install shims totaling approximately 0.060 inch thick.

**ORDNANCE MAINTENANCE — POWER TRAIN, BODY, AND FRAME FOR ¼-TON 4x4 TRUCK  
(WILLYS-OVERLAND MODEL MB AND FORD MODEL GPW)**

Start the outer bearing on the pinion. Install the oil slinger on the pinion.

**d. Adjust the Outer Bearing.** Place the universal joint flange on the pinion. Install the nut on the pinion and draw the universal joint flange down tight. Turn the universal joint flange. If there is a slight drag, the pinion bearing adjustment is correct. If the pinion turns with difficulty or cannot be turned by hand, shims should be added behind the outer bearing. If the pinion is too loose, shims should be removed. Remove the universal joint flange and add, or remove, shims, until the correct adjustment is obtained. After the correct adjustment is obtained, again remove the universal joint flange and install the oil seal on the pinion. Install the universal joint flange. Install the nut and cotter pin.

**e. Install Gears in Differential Case (fig. 58).** Place the axle shaft gear thrust washers on the two axle shaft gears. Place the axle shaft gears in the case. Place the two differential pinion thrust washers and gears in the case. Install the differential pinion gear shaft that secures the two differential pinion gears in the case. Install the pinion shaft lock pin in the case.

**f. Install Differential Ring Gear (fig. 58).** Place the differential ring gear in position on the case. Install the lock plates and cap screws that secure the ring gear to the case. Bend the ears of the lock plate on the cap screws.

**g. Install Roller Bearings on Case (fig. 68).** If all the original parts have been used in the differential assembly, add the same thickness of shims as originally used, and press the roller bearings on the case, then proceed with subparagraph **h**, below. If the original parts are not being used, or if the original shim thickness is not known, install the roller bearings on the case without the shims, and proceed with subparagraph **i**, below.

**h. Install Differential Assembly in Housing (fig. 47).** Place the bearing cups on the bearings. Tilt the bearing cups in order to start the assembly in the housing. Tap the bearing cups lightly until the assembly is seated firmly in the housing. Install the two bearing caps so that the numbers on the caps, and the housing face the same way, and match in every way as shown in figure 47. If the differential assembly being used is not the one originally in the axle, proceed with subparagraph **i**, below.

**i. Differential Assembly Adjustment (fig. 69).** Place the differential assembly in the housing with the bearing cups on the assembly. Slide the assembly to one side of the housing. Check the clearance between the bearing cup and differential housing with a

## POWER TRAIN

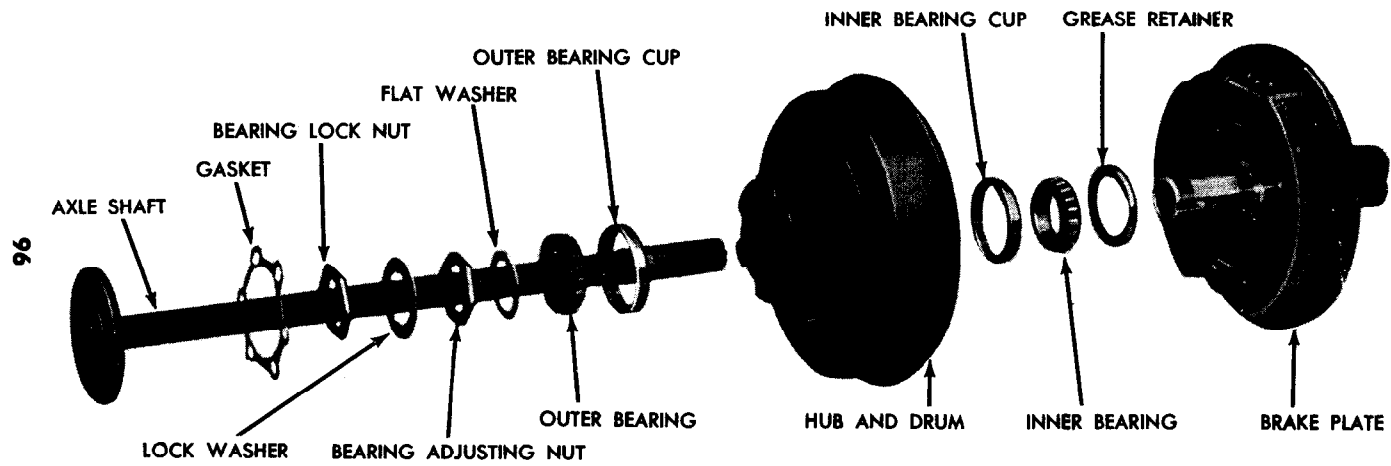
feeler gage. After this clearance has been determined, add 0.008 inch. This will give the thickness of shims required for proper bearing adjustment. Remove the differential assembly from the housing. Remove the bearings from the differential case (par. 24 f (3)). Install the number of shims, determined above, on each side of the case and install the bearings back on the case (par. 26 e (3)). Tilt the bearing cups in order to start the assembly in the housing. Tap the bearing cups lightly until the assembly is seated firmly in the housing. Install the two bearing caps so the numbers on the bearing caps and housing face the same way and match in every way.

j. **Check Backlash** (fig. 70). Install a dial indicator on the differential housing so that the indicator contact is resting on the surface of a ring gear tooth as shown in figure 70. Rotate the ring gear back and forth to determine the backlash. If the backlash is less than 0.005 inch or more than 0.007 inch, remove the differential from the housing (par. 24 e) and remove the bearings from the differential case (par. 24 f (3)). If the backlash was more than 0.007 inch, the ring gear must be brought closer to the pinion. If the backlash was less than 0.005 inch, the ring gear must be moved away from the pinion. This is accomplished by removing the shims, equal to the error in backlash, from one side of the case, and adding them to the other side of the case. Install the bearings on the case (subpar. g, above). Install the differential in the housing (subpar. h, above).

k. **Check Ring Gear Run-out** (fig. 71). Install a dial indicator on the differential housing so that the indicator contact is resting on the flat side of the ring gear as shown in figure 71. Turn the pinion drive flange by hand to determine the run-out of the ring gear. The run-out should not exceed 0.003 inch. If the run-out is more than 0.003 inch, remove the differential assembly from the housing (par. 24 e) and remove the ring gear from the differential case. Check the surface of the differential case and the ring gear for chips or small nicks which might have occurred during the assembly of the differential. If any small nicks are found, remove them with a fine stone; also check the flange on the differential case for being sprung. Reinstall the differential assembly in the housing (subpar. h, above) and recheck the ring gear run-out.

l. **Install Differential Cover** (fig. 78). Place a new gasket and the differential cover in place on the axle housing. Install the ten cap screws that secure the cover to the housing.

m. **Install Brake Plate** (fig. 82). Place the brake plate on the housing, with the brake cylinder on the brake plate toward the top. Line up the holes in the brake plate with the axle housing. Install the six cap screws that secure it to the axle housing. Install the hydraulic



96

RA PD 329142

Figure 82 — Axle Shaft — Exploded View

## POWER TRAIN

brake line at the connection on the brake plate. Install the flexible hydraulic brake line leading from the frame crossmember at the connection at the differential housing.

**n. Install Hub and Brake Drum (fig. 82).** Pack the wheel bearings with the specified lubricant. Install the inner bearing in place in the hub and install the hub and brake drum on the housing. Install the outer wheel bearing and thrust washers. Install and tighten the bearing adjusting nut until the brake drum binds, then back it off one-sixteenth turn. This will give the correct wheel bearing adjustment. Install the lock washer and lock nut. Bend the ears of the lock washer over the lock nut.

**o. Install Axle Shafts (fig. 82).** Insert the axle shaft in the axle housing. Turn the axle shaft to line up the splines on the axle shaft with the gear in the differential. Install the six cap screws that secure the drive flange to the hub.

**p. Install Wheels.** Place the wheel in position on the hub and secure it with five cap screws.

### 34. INSTALLATION.

**a. Preliminary Work.** Place the rear axle assembly under the vehicle. With a hydraulic jack, raise the rear axle high enough so that the spring shackles can be connected.

**b. Install Springs (fig. 77).** Raise the two rear springs and install them on the spring shackles. Install the spring shackle bushings in the spring shackles. Lower the jack until the axle assembly is resting on the springs, making sure that the spring tie bolt is in line with the hole on the axle housing.

**c. Install Spring U-bolts (fig. 77).** Place the spring U-bolts in position on the axle housing. Install the spring seat plate on the U-bolts and secure it to the spring with four nuts. The same procedure applies for installing the U-bolts on the other spring.

**d. Install Shock Absorbers (fig. 77).** Insert a rubber mounting in each side of each shock absorber eye. Place the lower end of the shock absorber on the bracket at the spring seat plate. If new shock absorber rubber mountings are being used, compress them with compressor 41-C-2554-400. Install the flat washer and cotter pin that secure the shock absorber to the bracket on the spring seat plate.

**e. Install Hydraulic Brake Line and Propeller Shaft.** Install the flexible hydraulic line to the connection at the differential housing (fig. 77). Connect the propeller shaft at the axle (par. 21 a).

**f. Lubricate.** Fill the differential to proper level with specified oil. Apply specified grease to all fittings. Bleed the hydraulic brake system. Refer to TM 9-803.

ORDNANCE MAINTENANCE — POWER TRAIN, BODY, AND FRAME FOR ¼-TON 4 x 4 TRUCK  
(WILLYS-OVERLAND MODEL MB AND FORD MODEL GPW)

Section VII

FITS AND TOLERANCES

35. FITS AND TOLERANCES.

Fits Location and Name	Manufacturers Fit Tolerance	Fit Wear Limit	Type of Fit
<b>a. Transmission.</b>			
Second speed gear bushing....	—	—	Press
Second speed gear and main- shaft .....	0.001-0.002 in.	0.004 in.	Running
Idle gear bushing.....	—	—	Press
Idle gear and idle gear shaft	0.003-0.0045 in.	0.005 in.	Running
Countershaft end play.....	0.004-0.016 in.	0.016 in.	—
Countershaft gear bushings and countershaft gear.....	0.0015-0.003 in.	0.005 in.	Running
Countershaft gear bushings and countershaft .....	0.0015-0.0025 in.	0.005 in.	Running
<b>b. Transfer Case.</b>			
Intermediate gear end play..	0.006-0.017 in.	0.017 in.	—
Output shaft bushing and clutch shaft .....	0.0015-0.003 in.	0.003 in.	Running
Shift lever pivot pin and shift levers .....	0.001-0.005 in.	0.010 in.	Slip
Output shaft and output shaft gear .....	0.0015-0.0025 in.	0.003 in.	Running
<b>c. Front Axle.</b>			
Differential pinion gears and differential pinion shaft....	0.0019-0.0044 in.	0.005 in.	Running
Axle shaft gear and differen- tial case .....	0.003-0.006 in.	0.006 in.	Running
Differential pinion adjust- ment .....	0.719 in.	0.719 in.	—
Differential ring gear back- lash .....	0.005-0.007 in.	0.005-0.007 in.	—
Differential ring gear run-out	0.003 in.	0.003 in.	—
Spindle housing tension.....	4 to 6 lb	4 to 6 lb pull scale	—
Bendix or Tracta axle shaft backlash .....	0.015-0.035 in.	0.015-0.035 in.	—
<b>d. Rear Axle.</b>			
Differential pinion gears and differential pinion shaft.....	0.0019-0.004 in.	0.005 in.	Running
Axle shaft gear and differen- tial case .....	0.003-0.006 in.	0.006 in.	Running
Differential ring gear back- lash .....	0.005-0.007 in.	0.005-0.007 in.	—
Differential pinion adjust- ment .....	0.719 in.	0.719 in.	—
Differential ring gear run-out	0.003 in.	0.003 in.	—

# TM 9-1803B

## CHAPTER 3

### BODY AND FRAME

#### Section I

#### SPRINGS AND SHOCK ABSORBERS

#### 36. SPRINGS.

##### a. Description and Data.

(1) **Description.** The front and rear springs are the semi-elliptic type. The front end of the front springs and the rear end of the rear springs are shackled, using the U-bolt type shackle with a threaded core bushing. The rear ends of the front springs and the front ends of the rear springs each have a bronze bushing and are each pivoted by a pivot bolt mounted to a bracket on the frame. A torque reaction spring, mounted on the left front spring, stabilizes the torque of the front axle. The front springs appear to be identical in construction but are different in load carrying ability. The left spring can be identified by the letter "L" stamped on the No. 8 leaf.

##### (2) DATA.

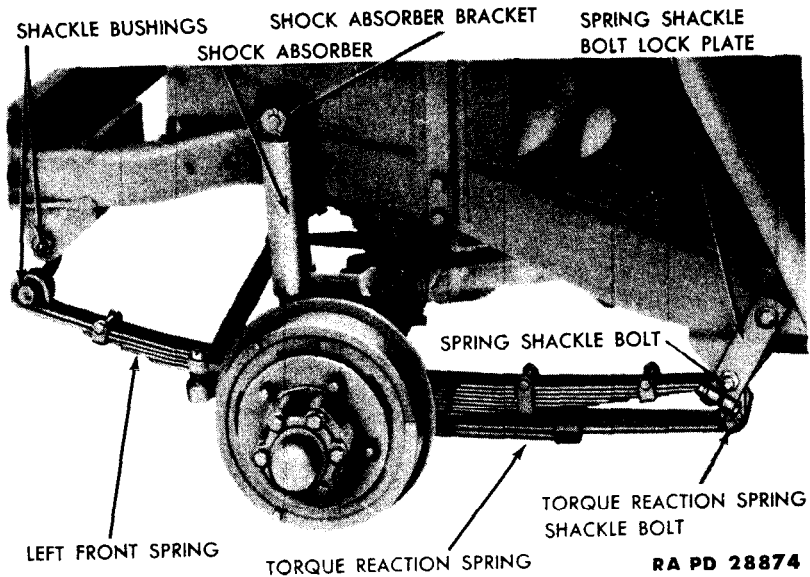
##### Front spring:

Make	Mather
Type leaf	Parabolic
Length (center to center of eye)	36¼ in.
Width	1¾ in.
Number of leaves	8
Front eye (center to center bolt)	18 <sup>1</sup> / <sub>8</sub> in.
Rear eye (center to center bolt)	18 <sup>1</sup> / <sub>8</sub> in.
Left camber under 525 lb	•~ in.
Right camber under 390 lb	6 in.
Rear eye	Bushing
Rebound clips	4

##### Rear springs:

Make	Mather
Type leaf	Parabolic
Length	42 in.
Width	1¾ in.
Number of leaves	9
Rebound clips	4
Camber under 800 lb	¾ in.
Eye to center bolt	21 in.
Front eye	Bushing

ORDNANCE MAINTENANCE — POWER TRAIN, BODY, AND FRAME FOR ¼-TON 4x4 TRUCK  
(WILLYS-OVERLAND MODEL MB AND FORD MODEL GPW)



**Figure 83 — Left Front Spring With Torque Reaction Spring**

**b. Removal.**

(1) **RIGHT FRONT SPRINGS** (fig. 35). Raise the vehicle frame until the weight is off the springs but the wheels are still on the floor. Remove the cotter pin and flat washer that secure the shock absorber to the spring seat plates. Remove the shock absorbers from the spring seat plates. Remove the four nuts from the spring U-bolts and remove the U-bolts and spring seat plates. Remove the two front shackle bushings from the spring shackles at the forward end of the frame. Remove the cotter pin and nut from the shackle bolt at the rear of the spring. Remove the shackle bolt from the spring. Remove the spring from the vehicle.

(2) **LEFT FRONT SPRING** (fig. 83). Raise the vehicle frame until the weight is off the springs but the wheels are still on the floor. Remove the cap screw that secures the shackle bolt lock plate to the left side of the frame. Remove the nut and bolt from the clamping end of the lock plate and remove the lock plate from the shackle bolt. Remove the cotter pin and flat washer that secure the lower end of the shock absorber to the torque reaction spring. Pull the shock absorber off the reaction spring. Remove the cotter pin and nut from the reaction spring shackle bolt and remove the shackle bolt. Remove the cotter pin and nut from the spring shackle bolt and remove

## BODY AND FRAME

the shackle bolt and shackles from the spring. Remove the four nuts from the U-bolts and remove the torque reaction spring. Remove the two spring shackle bushings from the spring shackle at the forward end of the spring. Remove the spring from the vehicle.

(3) **REAR SPRINGS** (fig. 77). Raise the rear of the vehicle frame until the weight is off the spring but the wheels still are on the floor. Remove the cotter pin and flat washer that secure each shock absorber to the spring seat plate. Remove the shock absorbers from the spring seat plates. Remove the four nuts from the spring U-bolts at both springs. Remove the U-bolts and spring seat plates. Remove the two shackle bushings from the spring shackle at the rear of the spring. Remove the spring shackles from the spring. Remove the cotter pin and castellated nut from the two shackle bolts at the front of the rear spring. Remove the two shackle bolts from the springs. Remove the rear springs from the vehicle.

### c. **Cleaning, Inspection, and Repair.**

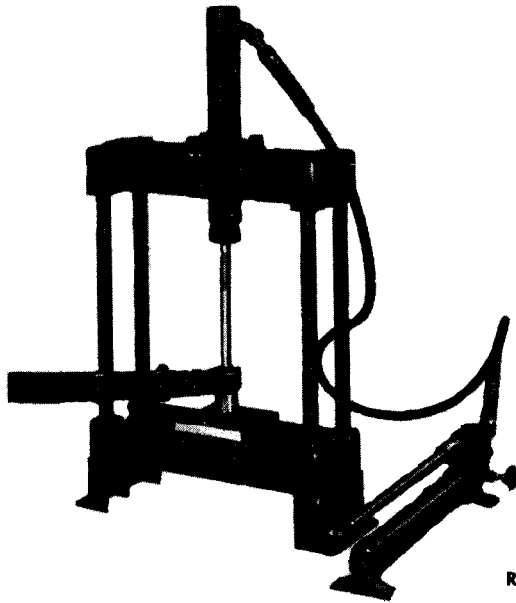
(1) **CLEANING AND INSPECTION** (figs. 85 and 86). Clean all parts in dry-cleaning solvent. Replace spring leaves or spring clips that are cracked or bent (step (2) (b), below). Replace spring shackles or shackle bolts that are bent or excessively worn. Replace the shackle bolt if the diameter is worn to less than 0.055 inch. Replace the spring bushing in the spring if the inside diameter is worn to more than 0.565 inch (step (2) (a), below). Replace the torque reaction leaves if they are cracked or bent. Replace the bushing in the torque reaction spring if worn to more than 0.566 inch (step (2) (a), below). Replace the inner shackle bushing if the inside diameter is worn to more than 0.570 inch. Replace the outer shackle bushing if the inside diameter is worn to more than 0.630 inch.

### (2) **REPAIR.**

(a) *Front and Rear Spring and Torque Reaction Spring Bushing Replacement* (fig. 84). Place the spring in a press and, with a suitable driver, press out the bushing. Press a new bushing in the spring, using the same driver.

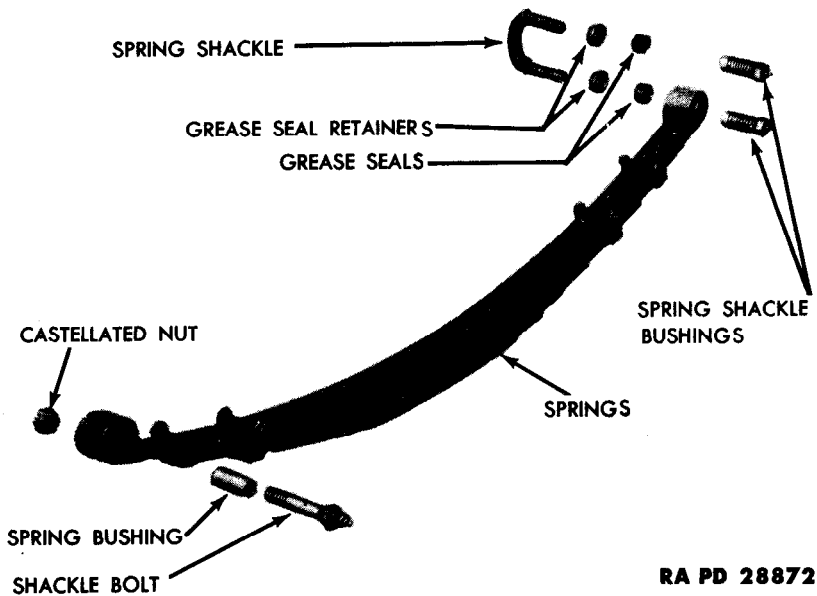
(b) *Spring Leaf Replacement* (fig. 86). Remove the nut and bolt from each of the four spring clips and remove the clips. Install a C-clamp next to the spring tie bolt to hold the tension of the spring leaves before removing the tie bolt. Remove the nut from the spring tie bolt and remove the spring tie bolt from the spring. Remove the C-clamp and separate the spring leaves. Replace the damaged or broken spring leaves. To reassemble the spring, place the spring leaves on the spring tie bolt, starting with the shortest leaf. Pull the leaves together in a vise or a suitable press and install the nut on the tie bolt. Install the four spring leaf clips on the spring.

**ORDNANCE MAINTENANCE — POWER TRAIN, BODY, AND FRAME FOR ¼-TON 4 x 4 TRUCK  
(WILLYS-OVERLAND MODEL MB AND FORD MODEL GPW)**



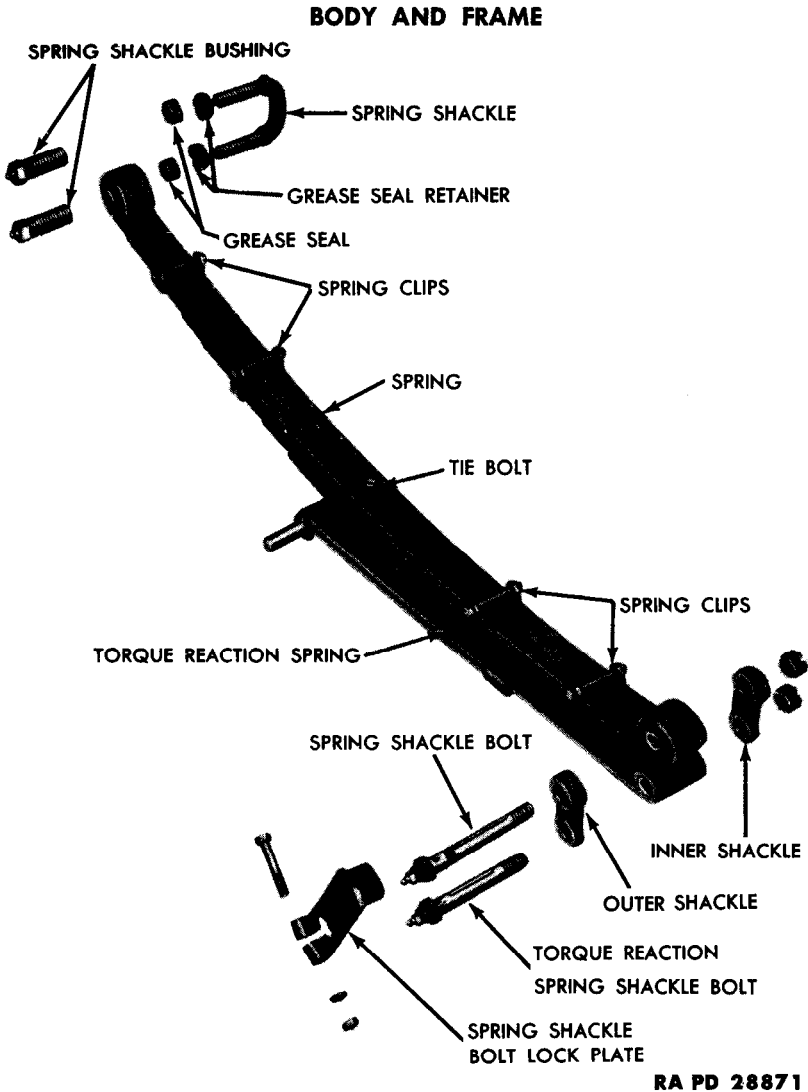
RA PD 28873

**Figure 84 — Pressing Bushing Out of Spring**



RA PD 28872

**Figure 85 — Rear Spring and Shackles**



**Figure 86 – Front Spring – Exploded View**

**d. Installation.**

(1) **RIGHT FRONT SPRING** (fig. 35). Place the front spring with the bushing end in the spring bracket on the frame. Insert the spring shackle bolt in the spring with the grease fitting facing outward. Install the nut and cotter pin on the shackle bolt. Raise the forward end of the spring and insert the spring shackle in the bracket on the frame and in the spring. Install the spring shackle bushing with the grease fittings facing outward. Place the spring U-bolts in position

**ORDNANCE MAINTENANCE — POWER TRAIN, BODY, AND FRAME FOR ¼-TON 4x4 TRUCK  
(WILLYS-OVERLAND MODEL MB AND FORD MODEL GPW)**

on the axle. Place the spring seat plate on the U-bolts. Install the the four nuts that secure the U-bolts to the axle housing. Install the lower end of the shock absorbers to the spring seat plate. Apply specified lubricant to all fittings.

(2) **LEFT FRONT SPRING** (fig. 83). Place the spring with the bushing end in the spring bracket on the frame. Insert the outer shackle on the shackle bolt. Insert the shackle bolt in the spring. Place the inner shackle on the shackle bolt and install the nut and cotter pin. Place the torque reaction spring between the inner and outer shackles. Insert the shackle bolt through the shackle and spring. Install the nut and cotter pin on the shackle bolt. Raise the forward end of the spring and insert the spring shackle in the spring. Install the spring shackle bushings with the grease fittings facing outward on the spring shackles. Place the spring U-bolts on the axle housing. Raise the torque reaction spring onto the U-bolts. Install the four nuts to the U-bolts. Install the lower end of the shock absorber to the torque reaction spring. Apply specified lubricant to all fittings.

(3) **REAR SPRINGS** (fig. 77). Place the rear spring with the bushing end in the spring bracket on the frame. Insert the spring shackle bolt in the spring with the grease fitting facing outward. Raise the rear end of the spring and insert the spring shackle in the spring and in the bracket on the frame. Install the two spring shackle bushings with the grease fitting facing outward. Place the spring U-bolts in position on the axle housing. Place the spring seat plate on the U-bolts. Install the four nuts that secure the spring seat plate to the U-bolts. Insert a rubber mounting in each side of each shock absorber eye. Place the lower end of the shock absorber on the bracket at the spring seat plate. If new shock absorber rubber mountings are being used, compress them with compressor 41-C-2554-400. Install the flat washer and cotter pin that secure the shock absorber to the spring seat plate.

### **37. GABRIEL SHOCK ABSORBER.**

#### **a. Description and Data.**

(1) **DESCRIPTION.** The Gabriel shock absorbers used on some of the vehicles can be distinguished from the Monroe type (par. 38) in that the upper tube has no cutaway section (fig. 87). Four of these direct-acting shock absorbers are used, one at each side of each axle. These shock absorbers are sealed at the factory with the proper amount of fluid and are non-refillable. These shock absorbers are adjustable (subpar. e, below).

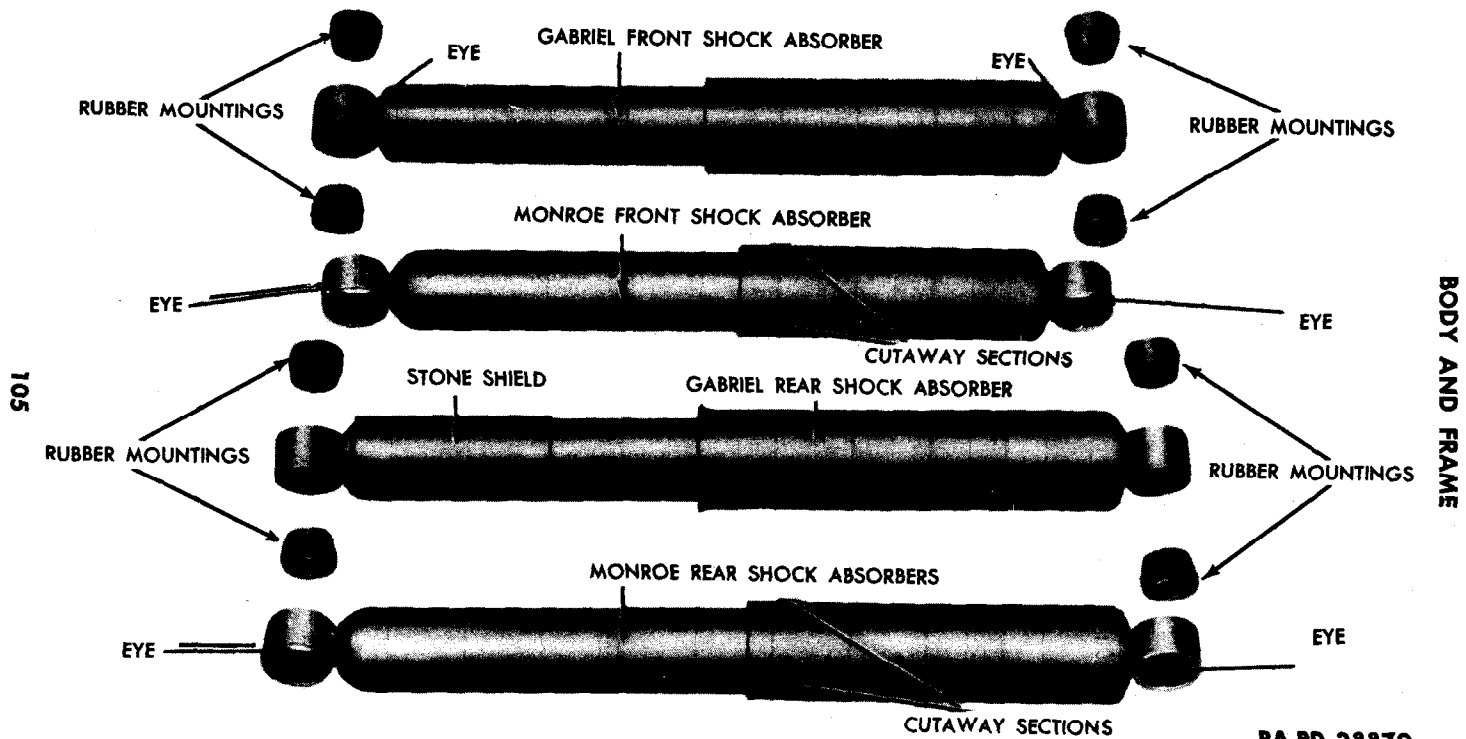


Figure 87 — Monroe and Gabriel Shock Absorbers

**ORDNANCE MAINTENANCE — POWER TRAIN, BODY, AND FRAME FOR ¼-TON 4 x 4 TRUCK  
(WILLYS-OVERLAND MODEL MB AND FORD MODEL GPW)**

**(2) DATA.**

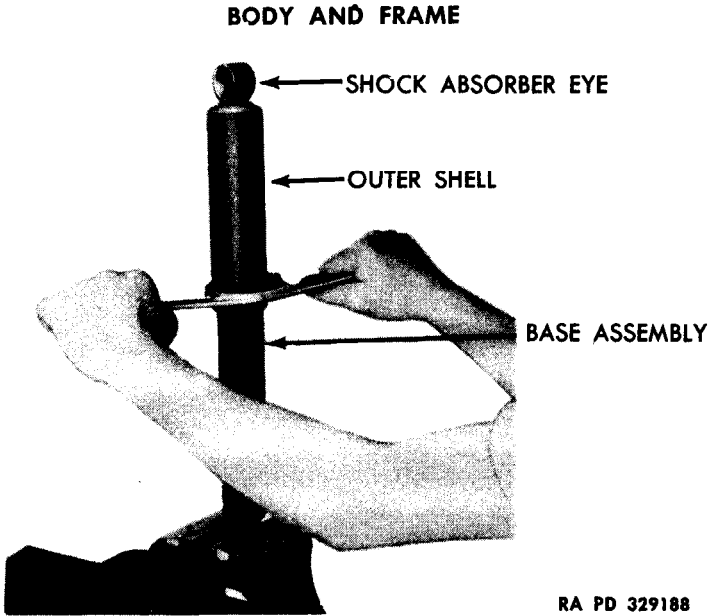
Make .....	Gabriel
Type .....	Hydraulic
Action .....	Double
Length compressed:	
Front .....	10 $\frac{5}{16}$ in.
Rear .....	11 $\frac{5}{16}$ in.
Length extended:	
Front .....	16 $\frac{5}{16}$ in.
Rear .....	18 $\frac{5}{16}$ in.
Mountings .....	Rubber

**b. Removal (figs. 35 and 77).** Remove the cotter pin and flat washer that secure the upper end of the shock absorber to the bracket on the frame. Remove the cotter pin and flat washer that secure the lower end of the shock absorber to the spring seat plate. Remove the shock absorber and rubber mountings from the vehicle.

**c. Cleaning and Inspection.** Wash the shock absorber with dry-cleaning solvent. If the shock absorber is cracked, excessively worn or is leaking fluid, replace the shock absorber. Replace the rubber mountings if they are excessively worn. Do not clean the shock absorber rubber mountings in dry-cleaning solvent.

**d. Installation (figs. 35 and 77).** Insert a rubber mounting in each side of the upper and lower eye of the shock absorber. Place the shock absorber onto the spring seat plate and onto the bracket on the frame. Install the flat washer and cotter pin that secure the upper end of the shock absorber to the frame. Install the flat washer and cotter pin that secure the lower end of the shock absorber to the spring seat plate. Install the rear shock absorbers so that the stone shield (fig. 87) on the shock absorber is facing forward on the vehicle.

**e. Adjustment.** Remove the cotter pin and flat washer from the lower end of the shock absorber and remove the lower end from the bracket. Push the unit together to engage the adjusting key, turn the lower half of the shock absorber clockwise until the limit of the adjustment is reached. Holding the unit together to keep the adjusting key still in the slot, turn the lower end of the shock absorber back (counterclockwise) one-half turn. This is the standard adjustment. Turning the adjustment to the right (clockwise) gives a firmer control for rough terrain, turning the adjustment counterclockwise establishes a softer control.



RA PD 329188

Figure 88 — Removing Seal Assembly With Special Spanner Wrench  
41-W-3336-745

### 38. MONROE SHOCK ABSORBER.

#### a. Description and Data.

(1) DESCRIPTION. The Monroe type shock absorber used on some of the vehicles can be distinguished from the Gabriel shock absorber by the cutaway sections on the outer shell of the shock absorber (fig. 87). Four of these direct-acting shock absorbers are used, one on each spring. These shock absorbers are refillable (subpar. e (5), below) and can be disassembled for repairs. They are also adjustable (subpar. e (3), below).

#### (2) DATA.

Make .....	Monroe
Type .....	Hydraulic
Action .....	Double
Length, compressed:	
Front .....	10 <sup>9</sup> / <sub>16</sub> in.
Rear .....	11 <sup>9</sup> / <sub>16</sub> in.
Length, extended:	
Front .....	16 <sup>1</sup> / <sub>8</sub> in.
Rear .....	18 <sup>1</sup> / <sub>8</sub> in.
Mountings .....	Rubber

RA PD 329198

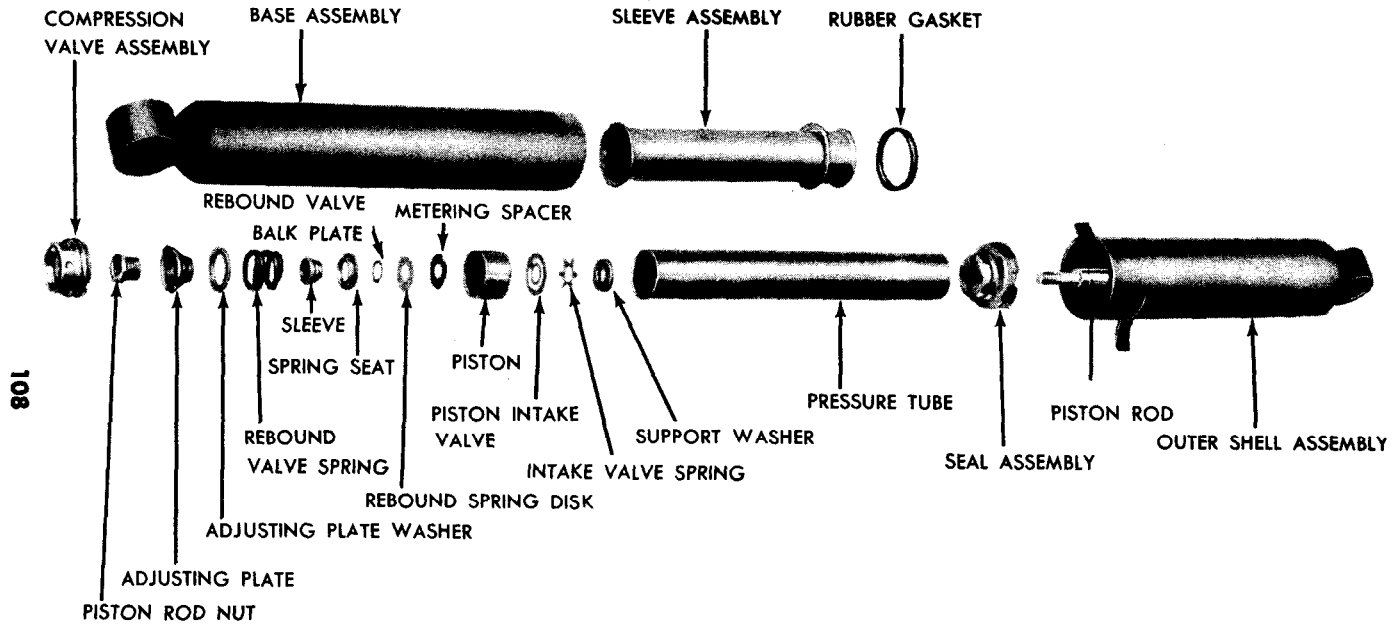


Figure 89 — Monroe Shock Absorber — Exploded View

## BODY AND FRAME

**h. Removal.** Remove the cotter pin and flat washer that secure the upper end of the shock absorber to the bracket on the frame. Remove the cotter pin and flat washer that secure the lower end of the shock absorber to the spring seat plate. Remove the shock absorber and rubber mountings from the vehicle. The same procedure applies to all four shock absorbers.

**c. Disassembly (figs. 88 and 89).** Place the eye of the base assembly in a vise. Pry open the two metal punch-out openings at the lower end of the outer shell. Install the special spanner wrench 41-W-3336-745 in the slots of the seal assembly and unscrew the seal assembly from the base. Pull the outer shell and pressure tube out of the base. Remove the base assembly from the vise and install the eye of the outer shell in the vise. Pry the compression valve assembly off the pressure tube, using a pair of pliers. Remove the shock absorber from the vise. Turn the pressure tube upside down and remove the fluid. Place the eye of the outer shell back in the vise in its original position. Push the pressure tube down into the outer shell. Remove the piston rod nut. Pull the pressure tube off the piston rod. Remove all of the internal parts from the pressure tube. Place a long drift in the pressure tube and tap the seal assembly out of the pressure tube.

**d. Cleaning and Inspection (fig. 89).** Clean all parts in dry-cleaning solvent. Replace the rubber gasket and seal assembly regardless of its condition. Replace all parts that are cracked, bent or excessively worn. Replace the piston if the diameter is worn to less than 0.997 inch. Replace the pressure tube if the inside diameter is worn to more than 1.001 inches. Replace the outer shell if the piston rod is bent or excessively worn. Replace the compression valve assembly if the valve spring is broken or if the adjustment slots are excessively worn. Replace the base assembly if there are any bad dents in the casing or if the threads are damaged. Replace the sleeve assembly if it is bent or out of shape.

### **e. Assembly.**

(1) **INSTALL PRESSURE TUBE AND INTERNAL PARTS (fig. 89).** Place the eye of the outer shell in a vise. Place the seal assembly at either end of the pressure tube and press the seal assembly in the tube. Install the special thimble 41-T-1657 on the threaded end of the piston rod. Push the pressure tube down into the outer shell and remove the pilot tool from the piston rod. Place the following parts on the piston rod in the order given; piston support washer with the flat surface facing down; intake valve spring with the bent ends facing up; piston intake valve; piston with the skirt of the piston facing up; metering spacer; rebound spring disk; rebound valve back plate; spring seat with the flat surface facing down; sleeve with the tapered

**ORDNANCE MAINTENANCE — POWER TRAIN, BODY, AND FRAME FOR ¼-TON 4 x 4 TRUCK  
(WILLYS-OVERLAND MODEL MB AND FORD MODEL GPW)**

end facing down; rebound valve spring; and adjusting plate washer. Screw the piston rod nut all the way into the adjusting plate. Install the nut and adjusting plate on the piston rod. Stake the rod and nut to prevent the nut from loosening.

(2) **FILL SHOCK ABSORBER WITH FLUID.** Pull the pressure tube out of the outer shell to its fullest extent. If working on a front shock absorber, measure 5 ounces of shock absorber fluid and put it in a clean container or 5¾ ounces if working on a rear shock absorber. Fill the pressure tube with fluid from this container to within ⅜ inch from the top. Pour the remaining amount of the measured fluid into the base assembly. Hold the pressure tube firmly and place the compression valve assembly on the tube. Tap the valve lightly until it is seated firmly in the pressure tube. Remove the outer shell from the vise and install the loop end of the base in the vise. Insert the sleeve assembly into the base assembly. Insert a new rubber gasket into the base assembly. Place the outer shell on the base. Using the special spanner wrench 41-W-3336-745, tighten the seal assembly into the base assembly (fig. 88).

(3) **ADJUST.** Push the unit together to engage the adjusting key, turn the base assembly (lower half) of the shock absorber clockwise until the limit of the adjustment is reached. Holding the unit together to keep the adjusting key still in the slot, turn the lower end of the shock absorber back (counterclockwise) two turns. This establishes the standard adjustment. Turning the adjustment to the right (clockwise) gives a firmer control for rough terrain, turning the adjustment counterclockwise establishes a softer control.

(4) **INSTALL.** Insert the rubber mountings in the upper and lower ends of the shock absorber. Install the shock absorber to the spring seat plate and to the frame. Install the flat washer and cotter pin that secure the upper end of the shock absorber to the frame. Install the flat washer and cotter pin that secure the lower end of the shock absorber to the spring seat plate.

(5) **REFILL SHOCK ABSORBER.** Remove the shock absorber (subpar. h, above). Place the eye end of the shock absorber base assembly in a vise. Pry open the two metal punch-out openings at the lower end of the outer shell. Install the special spanner wrench 41-W-3336-745 in the slots of the seal assembly (fig. 88). Unscrew the seal assembly from the base assembly. Pull the outer shell with the pressure tube out of the base assembly. Remove the base assembly from the vise and install the eye end of the outer shell in the vise. Pry the compression valve assembly off the pressure tube, using a pair of pliers. Fill the shock absorber with fluid as outlined in step (2), above.

## BODY AND FRAME

### Section II

## STEERING GEAR AND DRAG LINK

### 39. STEERING GEAR ASSEMBLY.

a. **Description.** The Ross Model T-12 steering gear (fig. 90) is of the cam and twin lever, variable ratio type, having a ratio of 14-12-14 to 1. The steering gear sector shaft is serrated for attachment of the Pitman arm, and the steering wheel is serrated for attachment to the worm and shaft assembly. The steering wheel is of the safety type, having three spokes and is 17 $\frac{1}{4}$  inches in diameter.

#### b. Removal.

(1) **REMOVE LEFT FRONT FENDER.** Remove the 12 bolts that secure the left front fender to the body, frame and radiator guard. Remove the bolt that secures the fender to the top of the frame in the engine compartment. Remove the wing nut that secures the headlight bracket to the fender. Disconnect the wires leading from the fender to the junction block on the cowl. Disconnect the wires leading from the junction block on the fender to the headlight and blackout light. Remove the fender from the vehicle.

(2) **REMOVE STEERING WHEEL.** Remove the steering wheel nut, horn button nut and horn button. Pull the steering wheel off the shaft with a steering wheel puller.

(3) **REMOVE STEERING COLUMN TUBE AND BEARING ASSEMBLY.** Remove the two nuts and bolts that secure the steering column support clamp at the instrument panel and remove the clamp. Remove the four metal screws that hold the steering column cover plate to the floor plate in the driver's compartment. Remove the two screws that hold the horn wire contact brush to the steering column and remove the brush. Loosen the bolt at the steering column clamp and slide the steering column tube and bearing assembly off the shaft.

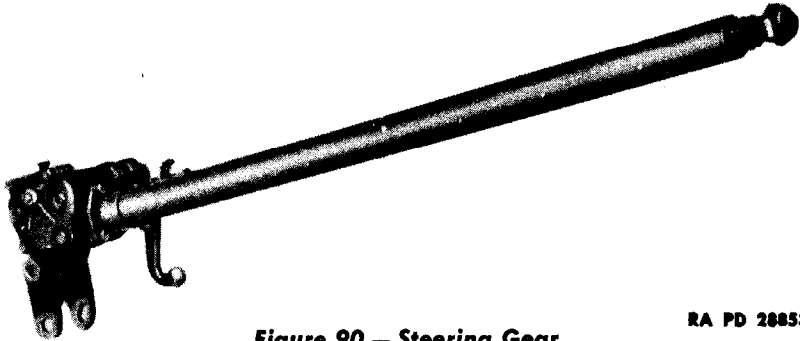
(4) **DISCONNECT DRAG LINK AT PITMAN ARM** (fig. 104). Remove the cotter pin from the Pitman arm end of the drag link. Loosen the drag link socket plug and lift the drag link off the Pitman arm.

(5) **REMOVE STEERING GEAR** (fig. 104). Remove the three bolts that hold the steering gear to the frame. Slide the steering gear assembly down through the floorboard and out over the frame.

#### c. Disassembly.

(1) **REMOVE PITMAN ARM** (fig. 92). Remove the nut and lock washer that hold the Pitman arm on the sector shaft assembly. Pull the Pitman arm off the steering sector shaft assembly with a standard Pitman arm puller.

**ORDNANCE MAINTENANCE — POWER TRAIN, BODY, AND FRAME FOR ¼-TON 4x4 TRUCK  
(WILLYS-OVERLAND MODEL MB AND FORD MODEL GPW)**



**Figure 90 — Steering Gear**

RA PD 28853

(2) **REMOVE STEERING SECTOR SHAFT ASSEMBLY** (fig. 92). Remove the four cap screws that hold the side cover to the housing and remove the side cover and gasket. Slide the sector shaft assembly from the housing.

(3) **REMOVE STEERING GEAR WORM AND SHAFT ASSEMBLY FROM HOUSING** (fig. 92). Remove the three cap screws that secure the housing end cover and shims to the housing. Slide the housing and shims off the worm and shaft assembly.

(4) **REMOVE STEERING GEAR WORM BEARINGS** (fig. 91). Remove the retainer ring that secures the steering gear worm lower bearing cup at the end of the shaft assembly. Remove the bearing cup and balls. Remove the retainer ring that secures the worm upper bearing cup to the shaft assembly. Slide the worm bearing cup up on the shaft and remove the balls.

**d. Cleaning, Inspection, and Repair.**

(1) **CLEANING AND INSPECTION** (figs. 91 and 97). Clean all parts thoroughly in dry-cleaning solvent. Replace a housing assembly or side cover that is cracked or damaged. Replace the expansion plug in the lower end of the housing if it is loose. Replace the inner and outer bushings in the housing (step (2) (c), below) if worn larger than 0.876 inch inside diameter. Replace a sector shaft assembly that has flat spots on the tapered studs or that has chipped studs. Replace the sector shaft if the shaft measures less than 0.870 inch at the bearing surfaces. Replace the worm and shaft assembly if the worm is excessively worn, ridged, scored, or chipped. Replace a worn, pitted, or cracked worm upper and lower bearing cup (step (2) (b), below). Replace a broken or damaged horn wire (step (2) (a), below). Replace a steering column tube that is bent or damaged. Replace the whole assembly if it is damaged. Replace

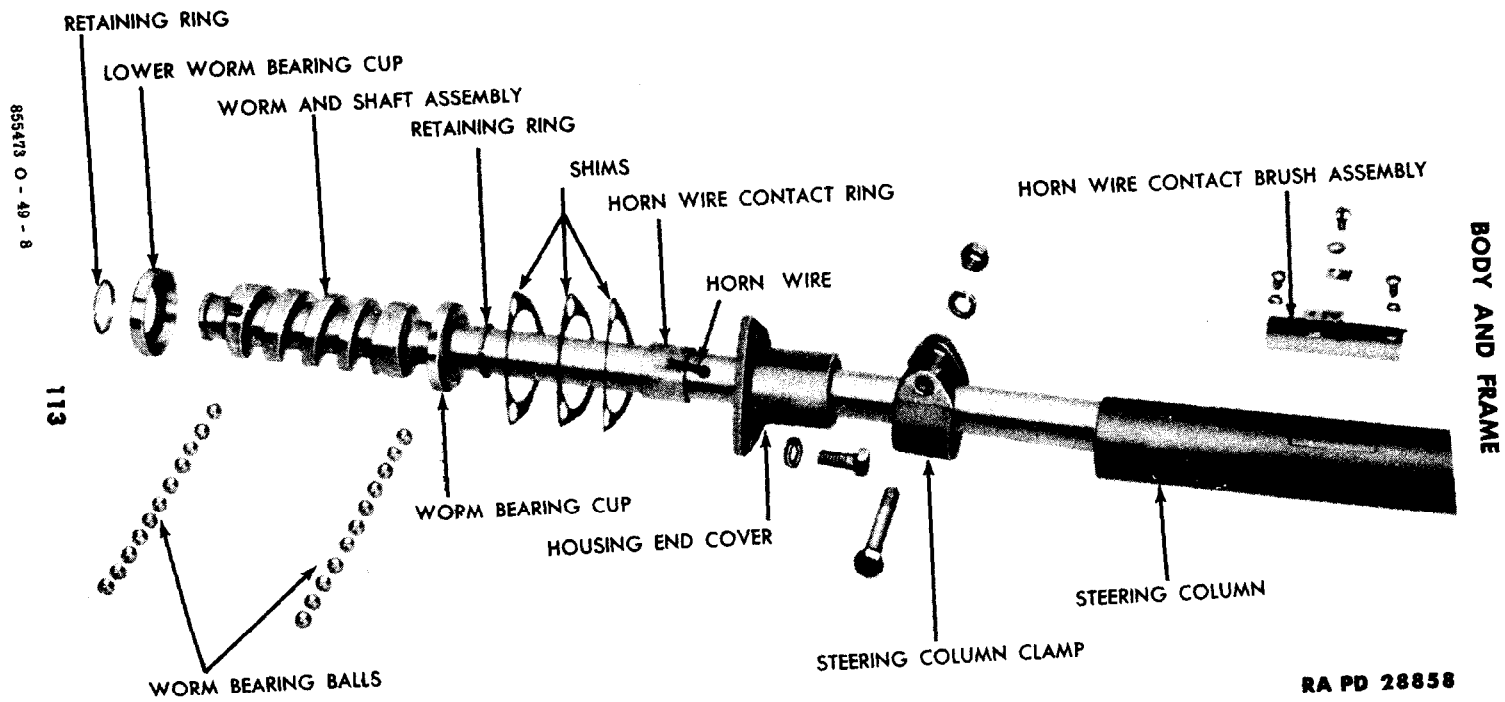
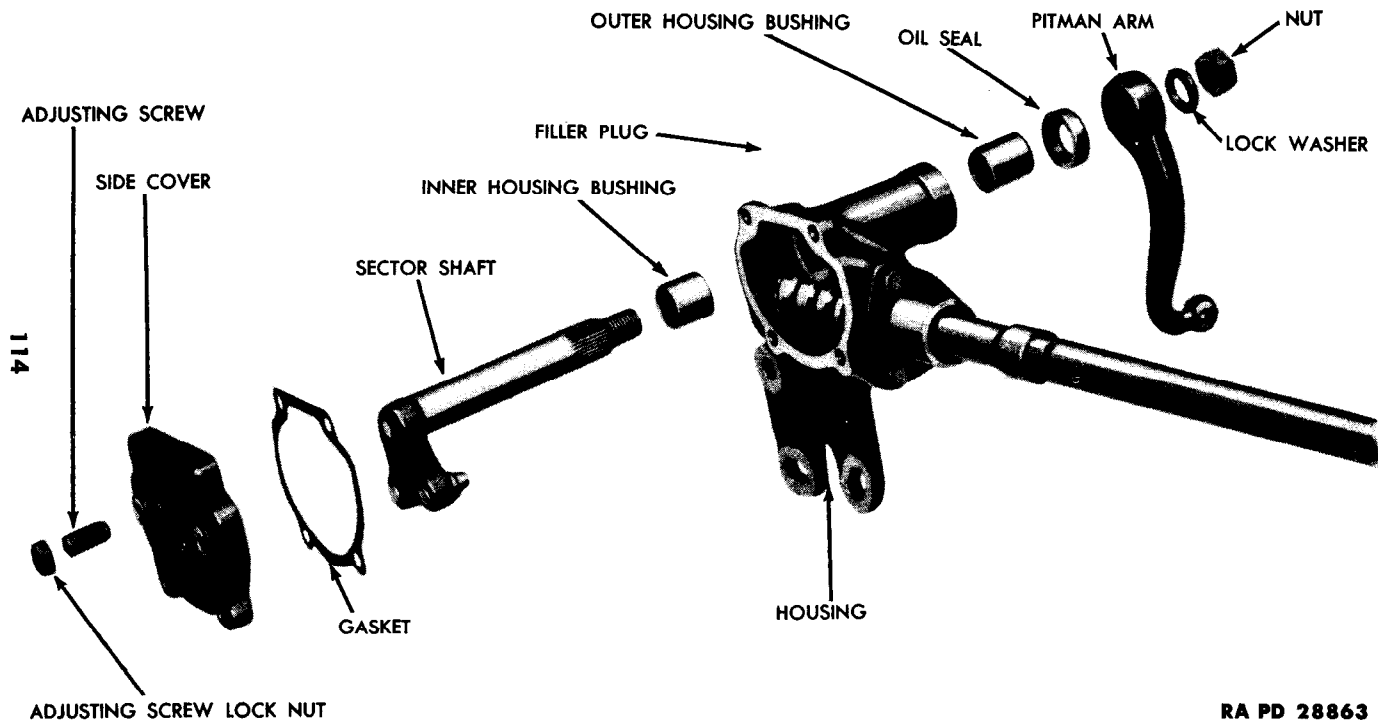


Figure 91 - Worm and Shaft Assembly - Exploded View



RA PD 28863

Figure 92 — Sector Shaft and Housing Assembly — Exploded View

BODY AND FRAME

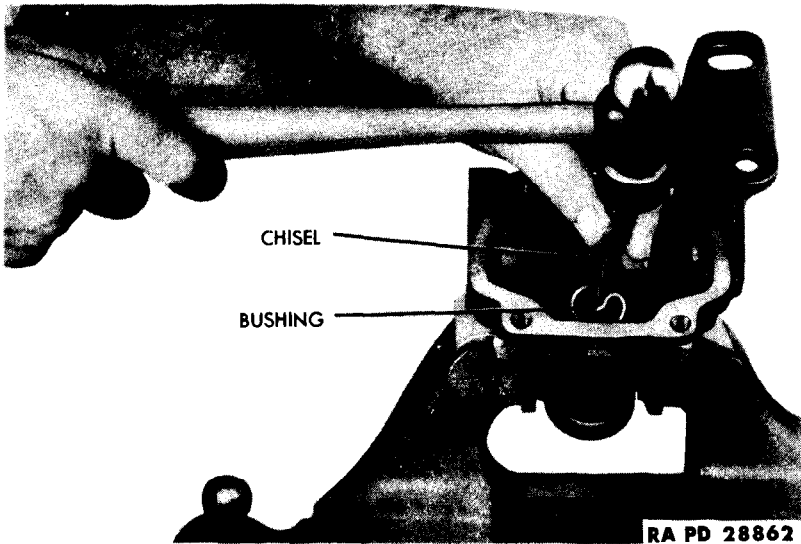


Figure 93 — Removing Housing Bushings

any balls with flat spots. Replace the steering column tube bearing if it is excessively worn.

(2) REPAIR.

(a) *Horn Wire Replacement* (fig. 96). Unsolder the horn wire at the horn wire contact ring and pull the wire assembly from the shaft. To install the horn wire, slide the contact washer, insulating ferrule, horn button spring and horn button spring cup onto the horn wire. Push the horn wire down through the shaft and out of the hole in the lower end of the shaft. Solder the horn wire onto the horn wire contact ring, making sure that none of the strands of wire or the solder are touching the shaft.

(b) *Worm Upper Bearing Cup Replacement*. Remove the horn wire (step (a), above). Unsolder the horn wire from the contact ring (fig. 96) and slide the ring off the shaft. Slide the worm upper bearing cap and retaining ring off the shaft. To reinstall the worm bearing cup on the shaft, slide the cup onto the shaft with the concave side toward the worm. Slide the retaining ring onto the shaft. Select a heavy flat washer that will slide onto the shaft, but will not slide over the horn wire contact ring. Make a mark on the lower part of the shaft with a file  $\frac{1}{2}$  inch below the horn wire hole. Slide the horn wire contact ring onto the shaft. Place the flat washer on the shaft and place the shaft assembly loosely in a vise (fig. 98). Using a fiber block to protect the shaft, drive down on the shaft until the mark on the shaft is even with the upper part of the horn

ORDNANCE MAINTENANCE — POWER TRAIN, BODY, AND FRAME FOR ½-TON 4x4 TRUCK  
(WILLYS-OVERLAND MODEL MB AND FORD MODEL 6PW)

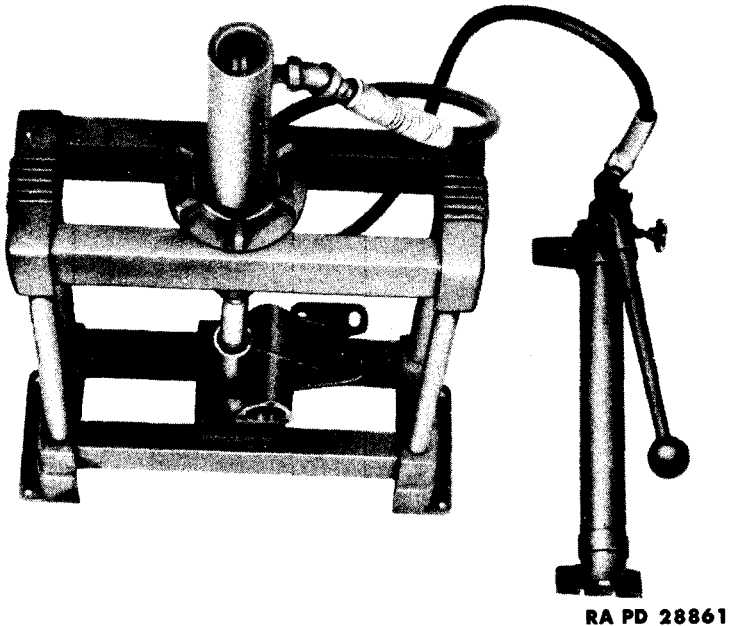


Figure 94 — Pressing Bushing in Steering Gear Housing

wire contact ring. Install the horn wire in the shaft (step (a), above).

(c) *Housing, Inner, and Outer, Bushing Replacement.* Remove the housing oil seal with a small punch or chisel. Drive a small punch or chisel between the housing and the joint in the bushings (fig. 93), until the ends of the bushings overlap. Tap the bushings out of the housing. To install the bushings, press the outer bushing into the housing (fig. 94) until it is flush with the oil seal shoulder in the housing assembly. Press the inner bushing into the housing. Ream the bushings to 0.875 inch diameter (fig. 95) with reamer 41-R-1220.

e. **Assembly.**

(1) **ASSEMBLE WORM AND SHAFT ASSEMBLY.** Place the 11 worm bearing balls in the upper worm bearing cup. Slide the cup and retainer ring in place. Place the balls in the lower worm bearing cup and install the cup and retainer ring on the lower end of the shaft.

(2) **INSTALL WORM AND SHAFT IN HOUSING.** Slide the worm and shaft assembly in the housing. Install shims approximately 0.024 inch thick and the housing end cover on the shaft (fig. 91).

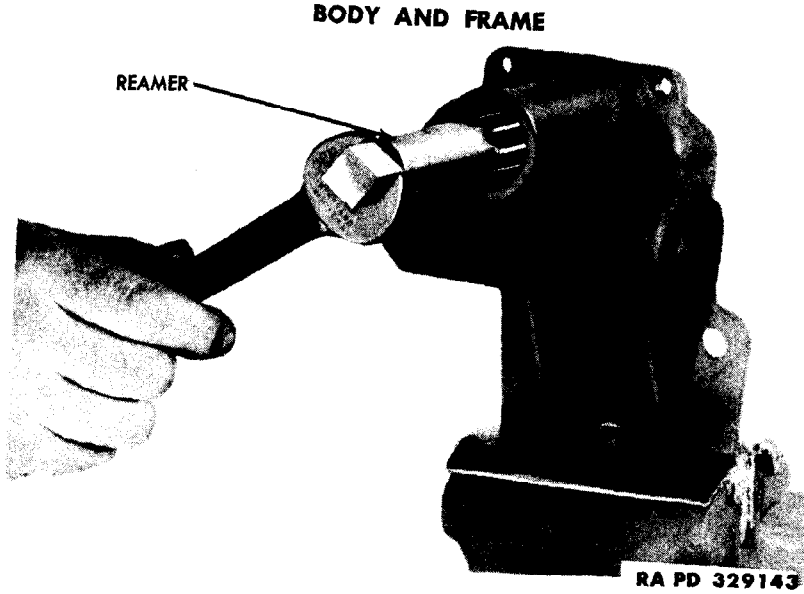


Figure 95 — Reaming Steering Gear Housing Bushing With Reamer 41-R-1220

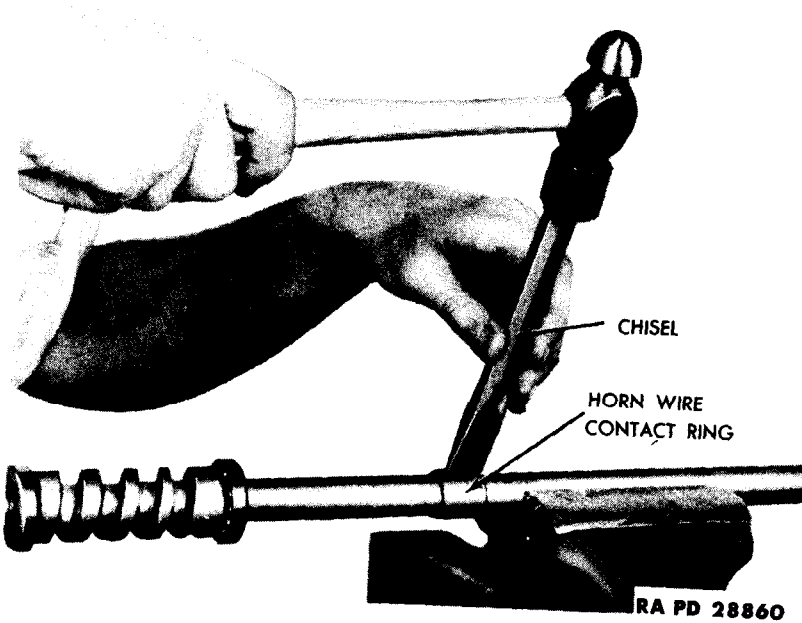


Figure 96 — Removing Horn Wire Contact Ring

**ORDNANCE MAINTENANCE — POWER TRAIN, BODY, AND FRAME FOR ¼-TON 4 x 4 TRUCK  
(WILLYS-OVERLAND MODEL MB AND FORD MODEL GPW)**

Install the three cap screws that secure the housing end cover. Turn the shaft by hand, if it is too tight, shims must be added, if too loose, shims must be removed. The correct adjustment is when shaft turns freely but has no end play. Shims are supplied in 0.0035, 0.0025 and 0.0065 inch thicknesses.

(3) **INSTALL SECTOR SHAFT ASSEMBLY** (fig. 92). Slide the sector shaft assembly into the housing, making sure the two tapered studs engage in the worm.

(4) **INSTALL SIDE COVER ON HOUSING**. Install a new side cover gasket and cover on the housing. Install the side adjusting screw and lock nut in the side cover (fig. 92). Turn the shaft counterclockwise until the shaft cannot be turned any farther. Turn the shaft clockwise until it cannot be turned any farther, counting the complete and part revolutions of the shaft and then turn the shaft counterclockwise half the number of turns. This will center the shaft. Turn the side adjusting screw in, until a slight drag on the shaft can be felt at this point. Tighten the adjusting screw lock nut and recheck the adjustment.

(5) **INSTALL STEERING COLUMN TUBE ON SHAFT** (fig. 91). Install the steering column clamp on the steering column with the bolt side of the clamp in line with the horn wire contact brush opening in the steering column. Slide the steering column tube down onto the housing end cover, making sure the horn wire contact brush opening in the steering column is in a vertical position when the housing base is in normal position. Tighten the clamp bolt.

(6) **INSTALL PITMAN ARM** (fig. 91). Place the Pitman arm on the sector shaft assembly, making sure the line on the Pitman arm is in line with the mark on the sector shaft assembly and that the ball joint on the Pitman arm is facing downward when the shaft is centered. Install the lock washer and nut that secure the Pitman arm to the sector shaft.

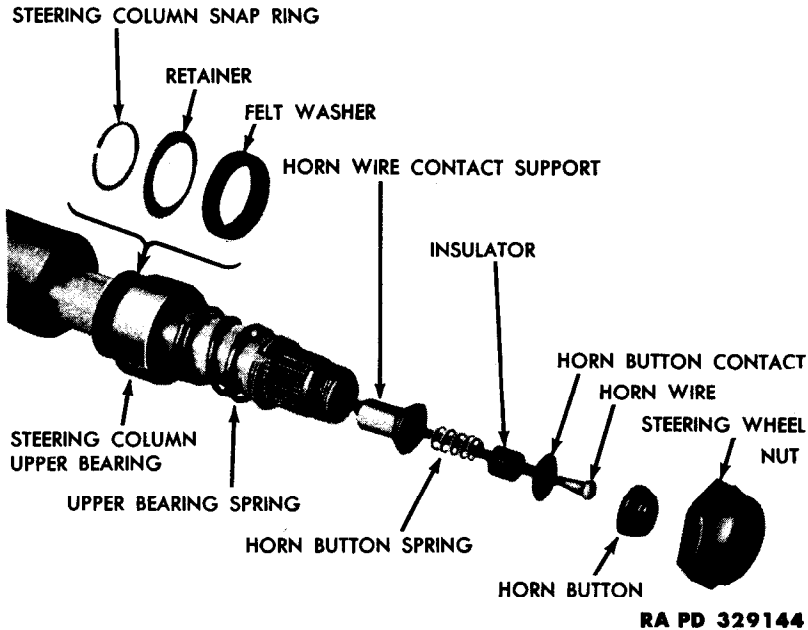
(7) **INSTALL HORN WIRE CONTACT BRUSH ASSEMBLY**. Hold the horn wire contact brush assembly in place on the steering column and install the two hold-down screws.

**f. Installation.**

(1) **INSTALL STEERING ASSEMBLY IN VEHICLE**. Slide the steering gear up through the floorboard. Install, but do not tighten, the three steering gear bolts.

(2) **CONNECT STEERING GEAR TO BRACKET**. Slide the steering column cover plate down the steering column and fasten it to the floorboard with four metal screws. Install the two bolts that secure the steering column clamp to the instrument panel in the driver's compartment.

**BODY AND FRAME**



**Figure 97 — Horn Button Assembly — Exploded View**

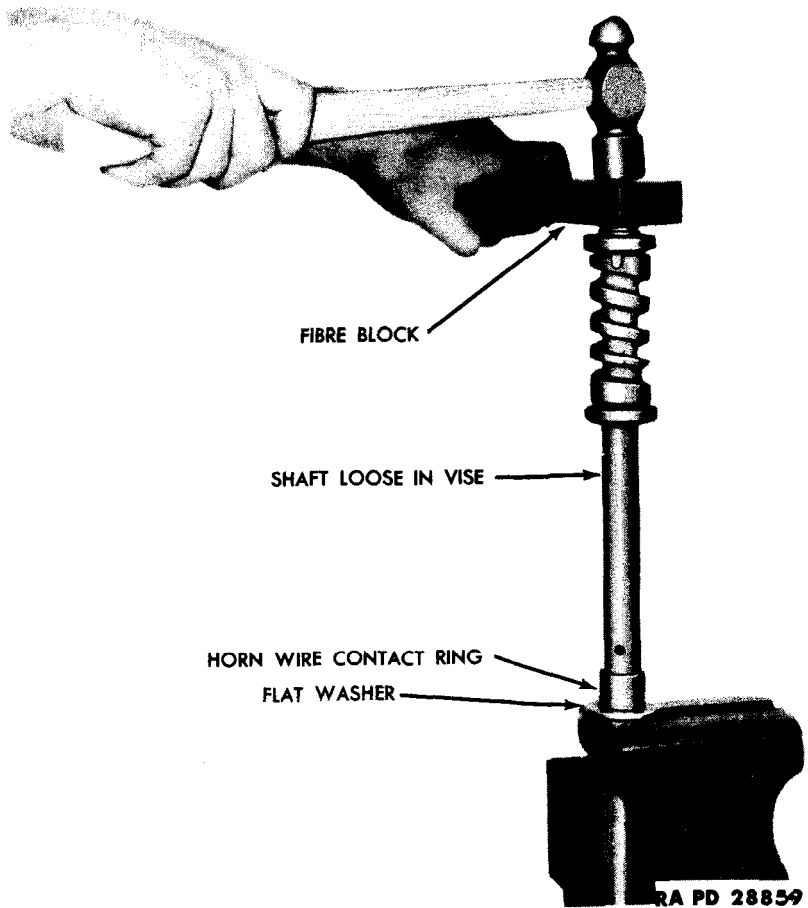
(3) **CONNECT DRAG LINK** (fig. 104). With the front wheels in a straight ahead position, connect the drag link to the Pitman arm, making sure the ball socket on the Pitman arm is between the socket and ball seat (fig. 99). Tighten the socket plug and install the cotter pin. Tighten the three steering gear hold-down bolts at the frame.

(4) **INSTALL HORN WIRE CONTACT BRUSH** (fig. 91). Hold the horn wire contact brush in place on the steering column and install the two hold-down screws. Connect the horn (live) wire to the contact brush.

(5) **INSTALL STEERING WHEEL** (fig. 97). Slide the steering column bearing spring and spring seat on the shaft. With the front wheels in a straight ahead position, place the steering wheel on the shaft with the center spoke in a vertical position and facing downward. Install the horn button and horn nut.

(6) **INSTALL FENDER AND REPLENISH LUBRICANT**. Place the fender in position on the vehicle. Install the 12 bolts that secure the fender to the frame, body, and radiator guard. Install the bolt that secures the fender on the frame in the engine compartment. Install the wires leading from the fender to the junction block on the cowl. Install the wires leading from the junction block on the

ORDNANCE MAINTENANCE — POWER TRAIN, BODY, AND FRAME FOR 1/4-TON 4x4 TRUCK  
(WILLYS-OVERLAND MODEL MB AND FORD MODEL GPW)



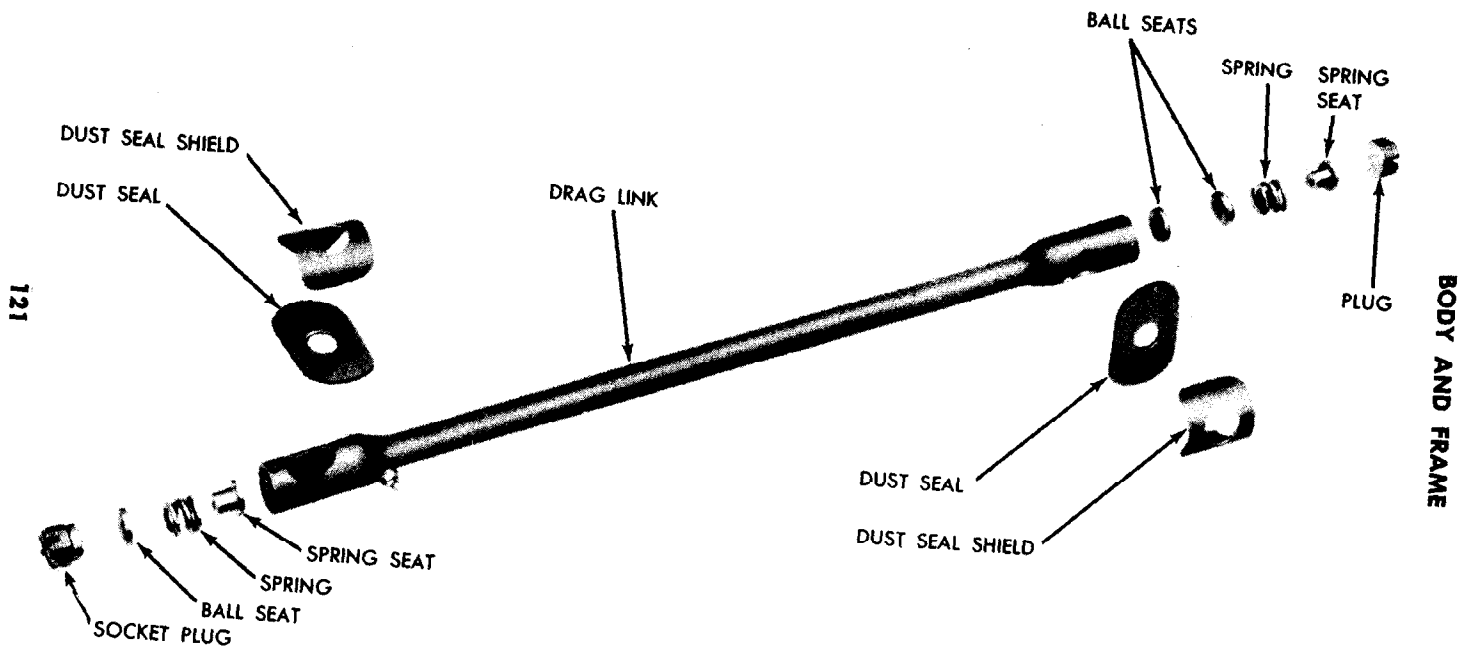
**Figure 98 — Installing Horn Wire Contact Ring**

fender to the headlight and blackout light. Replenish the lubricant, using the specified amount and grade (refer to TM 9-803).

**40. DRAG LINK.**

a. **Removal.** Remove the cotter pin from each end of the drag link. Loosen the adjusting plug at each end of the drag link. Lift the drag link from the vehicle.

b. **Disassembly.** Remove the dust seal shield and dust seal from each end of the drag link. Remove the adjusting plug, ball seat, spring, and spring seat from the front end of the drag link. Remove



121

Figure 99 - Drag Link - Exploded View

RA PD 28852

BODY AND FRAME

TM 9-180  
40

**ORDNANCE MAINTENANCE — POWER TRAIN, BODY, AND FRAME FOR ¼-TON 4 x 4 TRUCK  
(WILLYS-OVERLAND MODEL MB AND FORD MODEL GPW)**

the adjusting plug, spring seat, spring, and the two ball seats from the rear end of the drag link.

c. **Cleaning, Inspection, and Repair.** Clean all parts thoroughly in dry-cleaning solvent. Replace or straighten the drag link if it is bent. Replace damaged grease fittings. With a small wire, clean all grease fittings that are clogged. Replace excessively worn adjusting socket plugs or broken springs. Replace ball seats that are excessively worn. Replace excessively worn spring seats. Replace damaged dust shields or seals.

d. **Assembly (fig. 99).** Place a spring seat, spring and ball seat in the front end of the drag link. Screw the socket plug approximately three or four turns in the front end of the drag link. Place two ball seats, spring and spring seat in the rear end of the drag link. Screw the socket plug approximately three or four turns in the drag link.

e. **Installation (fig. 99).** Hold a new dust seal and a dust seal shield in place on the rear end of the drag link. Place the drag link on the Pitman arm, making sure the ball joint on the Pitman arm is seated between the spring seat and socket plug. Screw the socket plug in firmly against the ball, then back the plug off one full turn and install a cotter pin. Hold a new dust seal and dust seal shield in place on the front end of the drag link. Place the drag link on the intermediate steering arm, making sure the ball joint is seated between the spring seat and socket plug (fig. 99). Screw the adjusting plug in firmly against the ball and back off the socket plug one-half turn and install a cotter pin.

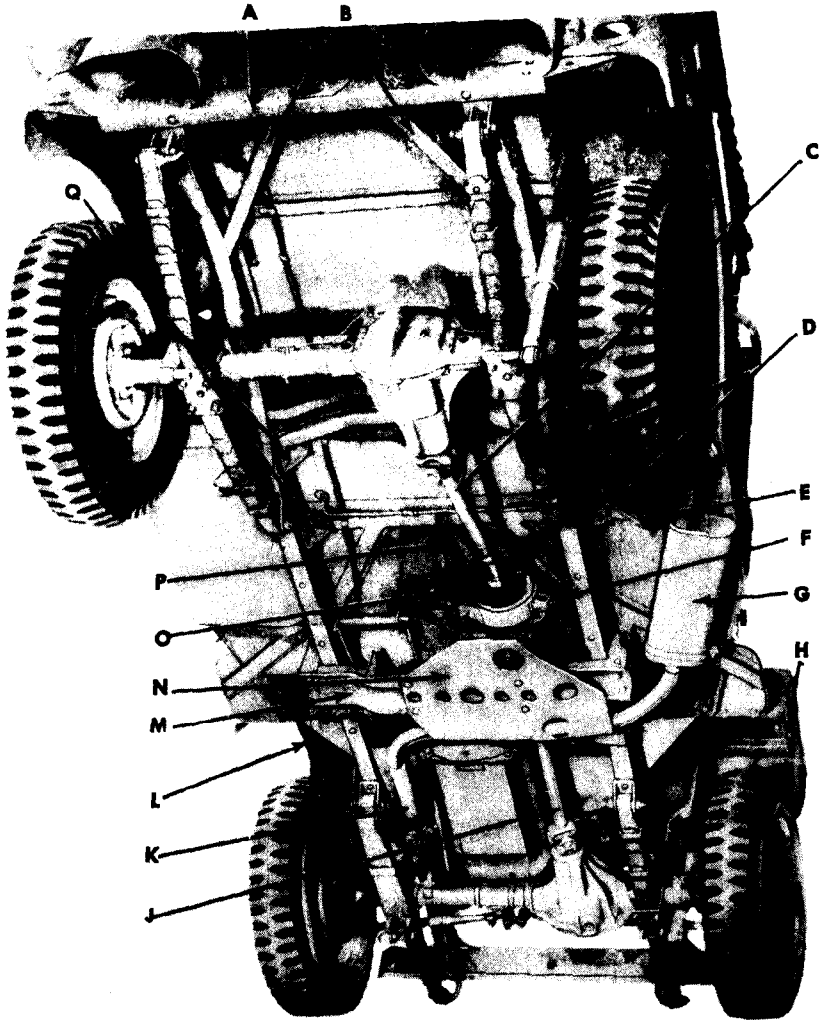
---

**Section III****BODY****41. REMOVAL.**

a. **Remove Hood and Windshield.** Raise the hood and remove the five bolts that secure the hood to the cowl. Remove the hood from the vehicle. Remove the wing nuts that secure the windshield at each side of the cowl. Remove the windshield from the vehicle.

b. **Remove Body Bolts From Frame (fig. 100).** Remove the five bolts under each fender that secure the fender to the body. Remove the four bolts that secure the body to the rear crossmember of the frame. Remove the two bolts that secure the body to the pintle hook brace. Remove the two bolts at each side of the frame that secure the body to the rear body brackets on the frame side member. Remove the bolts that secure the body at each side of the

BODY AND FRAME



- |                        |                                    |
|------------------------|------------------------------------|
| A REAR CROSSMEMBER     | J FRONT PROPELLER SHAFT            |
| B PINTLE HOOK BRACE    | K EXHAUST PIPE                     |
| C REAR PROPELLER SHAFT | L FRONT FENDER                     |
| D BODY BRACKETS        | M TRANSMISSION SUPPORT CROSSMEMBER |
| E GROUND STRAP         | N TRANSMISSION SHIELD              |
| F SPEEDOMETER CABLE    | O HAND BRAKE CABLE                 |
| G MUFFLER              | P HAND BRAKE SPRING                |
| H FRONT FENDER         | Q BODY BRACKETS                    |

RA PD 329148

Figure 100 — Under Side of Body

ORDNANCE MAINTENANCE — POWER TRAIN, BODY, AND FRAME FOR 1/4-TON 4x4 TRUCK  
(WILLYS-OVERLAND MODEL MB AND FORD MODEL GPW)

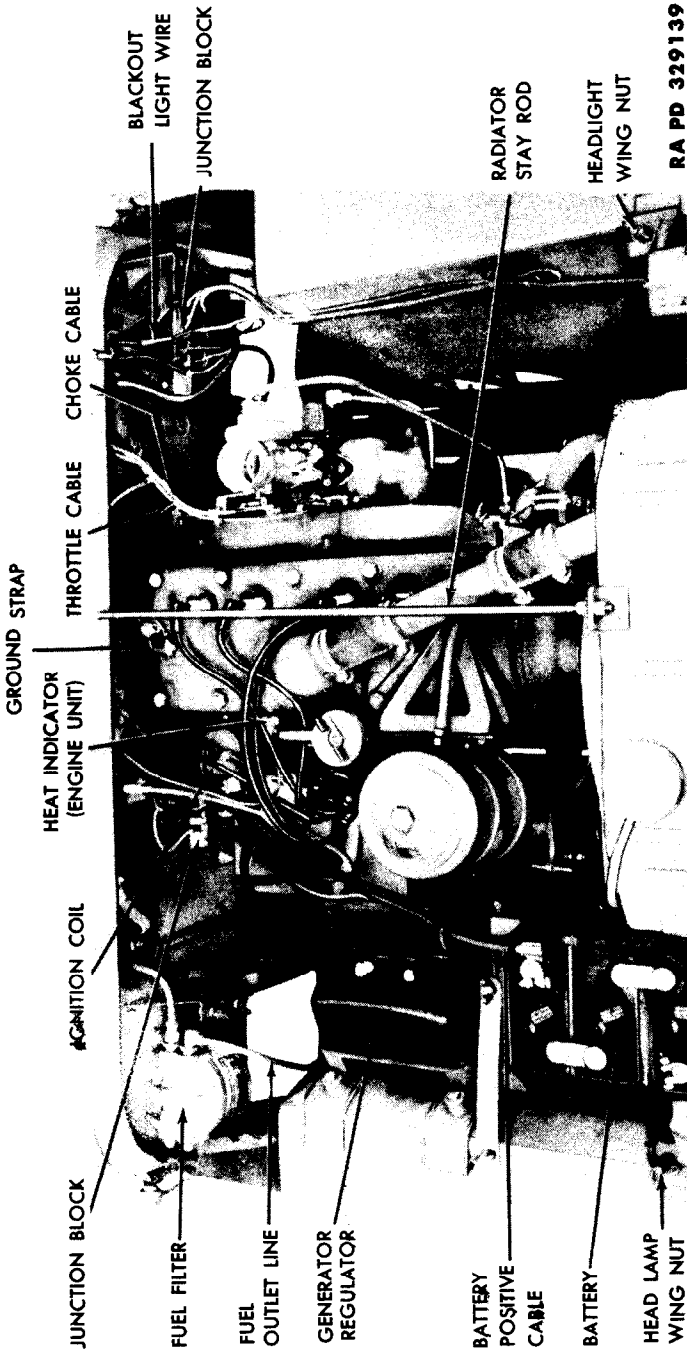


Figure 101 — View of Electrical Wires and Tubes on Cowl

## BODY AND FRAME

transmission support crossmember. Remove the bolts that secure the body at each side of the frame at the forward end of the body.

c. **Disconnect Hand Brake Cable and Speedometer Cable** (fig. 100). Remove the hand brake spring at the transfer case. Remove the clevis pin that secures the hand brake cable at the brake on the transfer case. Remove the hand brake cable clamp on the transmission. Disconnect the speedometer cable at the transfer case.

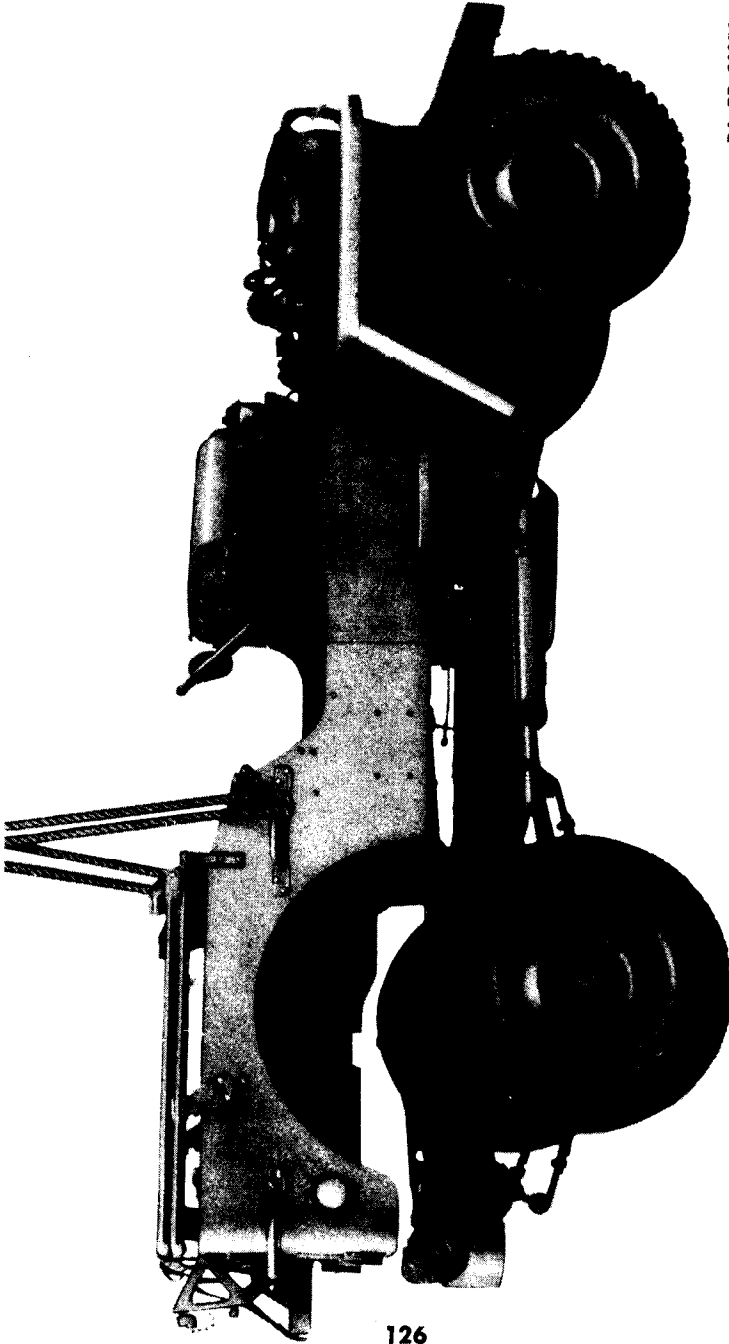
d. **Disconnect Ground Straps and Muffler** (fig. 100). Disconnect the ground strap at the left side of the transmission. Disconnect the ground strap leading from the body to the right side of the frame at the muffler. Remove the two nuts and bolts that secure the muffler to the body.

e. **Remove Air Cleaner**. Loosen the hose clamp that secures the air cleaner hose at the air cleaner. Remove the hose from the air cleaner. Remove the four wing nuts that secure the air cleaner to the brackets on the cowl.

f. **Remove Clutch and Brake Pedal Pads and Steering Wheel**. Remove the cap screw from the clamp at the bottom of the clutch pedal under the floor plate and remove the clutch pedal pads. Remove the cap screw from the clamp under the floor plate at the bottom of the brake pedal and remove the brake pedal. Remove the nut that secures the steering wheel to the steering shaft and remove the steering wheel, using a steering wheel puller. Disconnect the foot accelerator in the driver's compartment.

g. **Disconnect Miscellaneous Wires and Tubes in Engine Compartment** (fig. 101). Disconnect the positive cable at the battery. Disconnect the wire leading from the junction block at the left side of the cowl to the generator regulator. Disconnect the wire leading from the ignition coil to the junction block. Disconnect the battery cable at the starting switch. Disconnect the ground strap leading from the cylinder to the cowl. *NOTE: When removing the wires, tag them for later identification.* Disconnect the fuel outlet line at the fuel filter. Disconnect the three wires leading from the left fender to the junction block at the left side of the cowl. Disconnect the blackout light wire at the connection at the cowl. Disconnect the two wires at the hydraulic brake master cylinder. Disconnect the wire at the bottom of the steering tube. Disconnect the choke and throttle cable at the carburetor. Disconnect the oil line leading to the oil gage at the flexible connection at the left side of the engine. Disconnect the radiator stay rod at the radiator and cowl and remove the stay rod. Drain the coolant from the radiator and remove the heat indicator (engine unit) at the right-hand side of the cylinder head.

ORDNANCE MAINTENANCE — POWER TRAIN, BODY, AND FRAME FOR ¼-TON 4x4 TRUCK  
(WILLYS-OVERLAND MODEL MB AND FORD MODEL GPW)



RA PD 28856

Figure 102 — Raising Body From Chassis

## BODY AND FRAME

**h. Remove Body From Frame (fig. 102).** Install a rope on the two forward lifting handles on the body and raise the body slowly off the frame. While raising the body, move it toward the rear of the vehicle until the steering tube is clear of the body. Remove the body from the vehicle.

### 42. INSTALLATION.

**a. Place Body in Position on Frame (fig. 102).** Install a rope on the two lifting handles at the forward end of the body. Position the body over the chassis. Line up the steering post with the hole provided in the floor plate of the body. Lower the body slowly and at the same time roll the chassis under the body so as to follow the angle of the steering post until the body is resting on the frame.

**b. Install Body Bolts (fig. 100).** Install the two bolts that secure the body to each side of the frame at the forward end of the body. Install the four bolts that secure the body to the rear crossmember of the frame. Install the two bolts that secure the body to the pintle hook brace. Install the two bolts that secure the body to the two brackets on each frame side member. Install the bolt that secures the body to each side of the transmission support crossmember.

**c. Connect Hand Brake Cable and Speedometer Cable (fig. 100).** Connect the speedometer cable to the transfer case. Install the clevis pin that secures the hand brake cable at the brake linkage on the transfer case. Install the hand brake cable clamp to the transmission. Install the spring leading from the hand brake to the floor plate.

**d. Connect Muffler and Ground Straps (fig. 100).** Install the two nuts and bolts that secure the muffler to the right-hand side of the body. Connect the ground strap leading from the left side of the transmission to the floor plate. Connect the ground strap leading from the body to the right-hand side of the frame.

**e. Install Miscellaneous Wires and Tubes in Engine Compartment (fig. 101).** Install the heat indicator (engine unit) at the right-hand side of the cylinder head. Install the radiator stay rod to the radiator and at the cowl. Connect the gage oil line at the flexible connection on the left side of the cylinder block. Connect the choke and throttle cables at the carburetor. Connect the horn wire at the bottom of the steering post. Connect the two stop light wires at the hydraulic brake master cylinder. Connect the blackout light wire at the connection at the cowl. Connect the three headlight wires on the left fender to junction block at the left side of the cowl. Connect the ground strap leading from the rear of the cylinder head to the cowl. Connect the battery cable at the starting motor switch. Connect the wire leading from the coil to the junction block at the right-hand side

**ORDNANCE MAINTENANCE — POWER TRAIN, BODY, AND FRAME FOR ¼-TON 4 x 4 TRUCK  
(WILLYS-OVERLAND MODEL MB AND FORD MODEL GPW)**

of the cowl. Connect the wire leading from the junction block at the left side of the cowl to the generator regulator. Connect the positive cable at the battery. Connect the fuel line at the fuel filter.

**f. Install Clutch and Brake Pedal Pads and Steering Wheel.** Place the clutch and brake pedal pads in the clutch and brake pedals so that the raised ends of the pedal pads are toward the steering post. Install the two cap screws that secure the pedals to the levers. Install the steering wheel on the steering shaft. Connect the foot accelerator to the accelerator rod. Install the transmission gear shift lever on the transmission.

**g. Install Air Cleaner.** Install the air cleaner with four wing nuts securing it to the brackets on the cowl. Connect the air cleaner hose to the air cleaner.

**h. Install Hood and Windshield.** Place the hood in position on the vehicle and install the five cap screws that secure the hood to the cowl. Place the windshield in position on the cowl and install the wing nuts that secure the windshield at each side of the cowl.

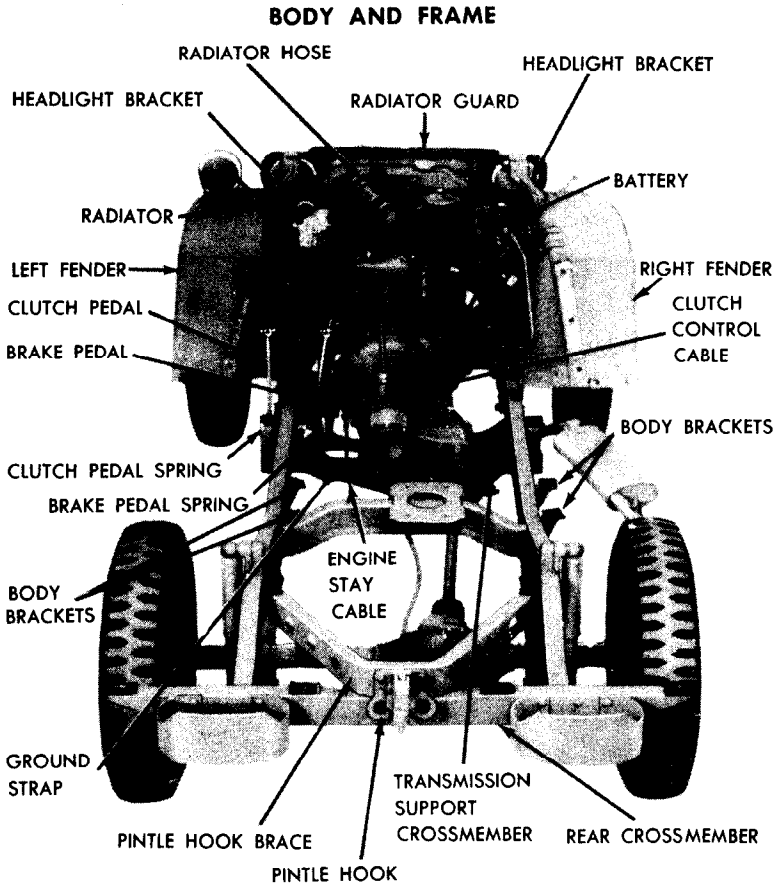
---

**Section IV****FRAME****43. INSPECTION BEFORE REMOVAL.**

**a.** Position the vehicle on a clean level floor. Attach a plumb bob to the grease fittings at the forward ends of the front spring shackle brackets. Mark the floor at the point indicated by the plumb bob. Attach the plumb bob to the grease fittings at the rear of the rear spring shackle brackets and mark the floor at the point indicated by the plumb bob. Move the vehicle off the markings on the floor. Measuring from the markings on the floor, compare the distance between the front shackle and the rear shackle on the one side of the vehicle with the same measurement on the opposite side of the vehicle, and compare the diagonal distance between each of the front shackles and the rear shackles on the opposite side of the vehicle. Differences of more than ¼ inch in these measurements indicate misalignment that must be corrected. If these comparative measurements are the same within ¼ inch, the frame is not misaligned.

**44. REMOVAL.**

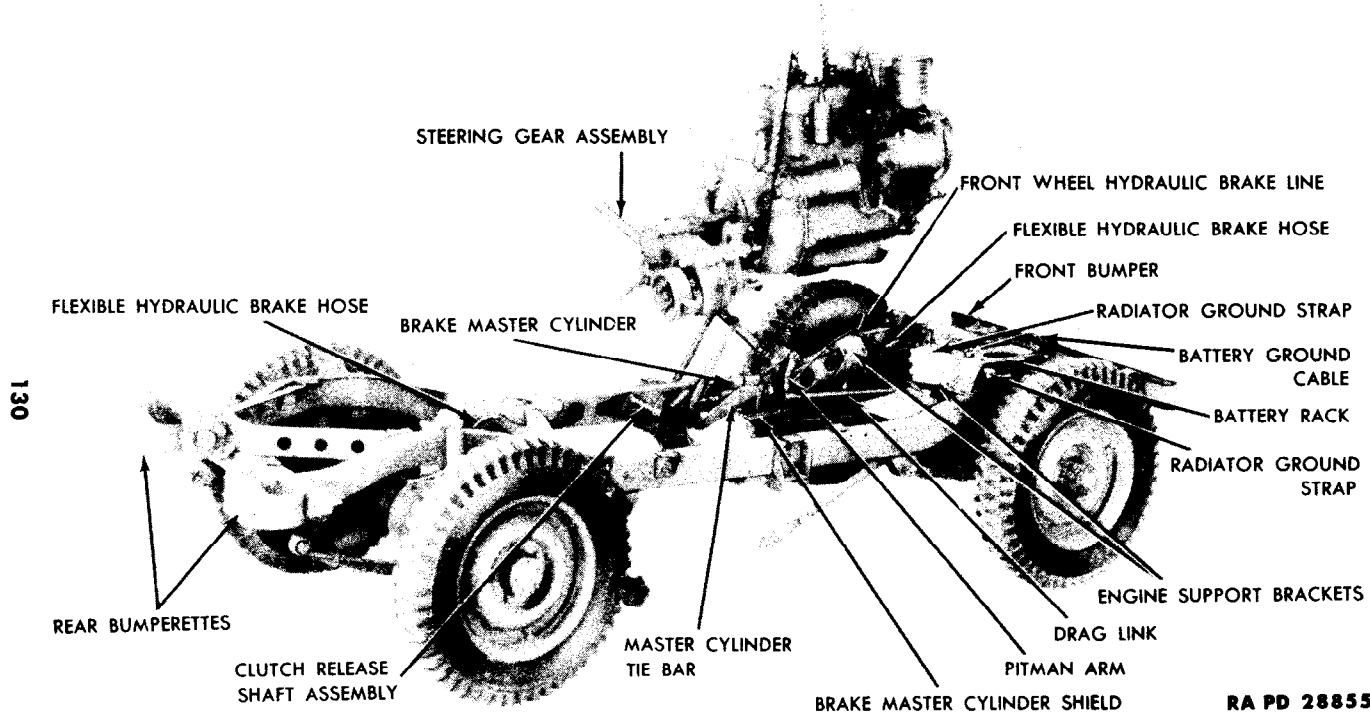
**a. Remove Battery** (fig. 101). Disconnect the positive and negative cables from the battery. Remove the two wing nuts that secure the battery hold-down rack and remove the rack from the battery.



**Figure 103 – Chassis**

**b. Remove Body and Fenders.** Remove the body (par. 40). Loosen the wing nuts that secure the headlight support bracket to the top of the fenders. Remove the seven bolts that secure the right-hand fender to the frame and to the radiator guard and remove the fender. Remove the eight bolts that secure the left fender to the frame and to the radiator guard, and remove the fender.

**c. Remove Radiator and Radiator Guard (fig. 103).** Drain the coolant from the radiator. Disconnect the hose connections at the top and bottom of the radiator. Remove the two bolts that secure the radiator to the frame front crossmember and remove the radiator. Remove the three nuts that secure the radiator guard to the frame front crossmember and remove the radiator guard.



RA PD 28855

Figure 104 — Removing Engine From Chassis

**BODY AND FRAME**

**d. Remove Exhaust Pipe and Transmission Shield (fig. 100).** Remove the two bolts that secure the exhaust pipe at the exhaust manifold. Remove the five bolts that secure the transmission shield to the transmission support crossmember. Remove the exhaust pipe and shield from the vehicle.

**e. Disconnect the Propeller Shafts (fig. 100).** Remove the two U-bolts that secure the front propeller shaft to the transfer case. Remove the propeller shaft from the universal joint flange on the transfer case. Remove the four nuts that secure the rear propeller shaft to the transfer case. Remove the propeller shaft from the transfer case.

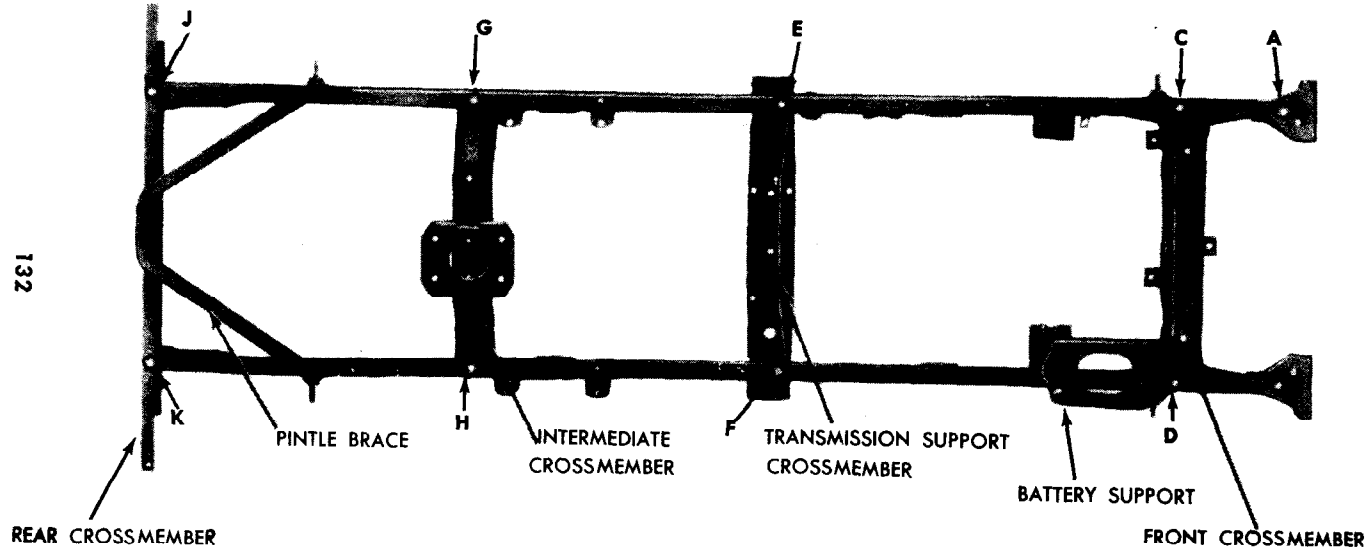
**f. Remove Front and Rear Bumpers (fig. 104).** Remove the eight nuts and bolts that secure the two rear bumperettes to the rear crossmember of the frame and remove the bumperettes. Remove the four nuts and bolts that secure the front bumper bar to the frame and remove the bumper bar.

**g. Remove Engine From Vehicle (figs. 103 and 104).** Remove the two nuts that secure the transmission to the transmission support crossmember. Remove the ground strap leading from the transmission support crossmember to the transmission. Remove the two nuts that secure the engine stay cable to the transmission support crossmember. Remove the clevis pin that secures the clutch control cable to the clutch release shaft. Remove the two nuts and cap screws that secure the engine mounting to the engine support brackets on each side of the frame. Remove the two ground straps leading from both engine support brackets to the engine. Install a suitable lifting sling on the engine and remove the engine from the frame.

**h. Remove Steering Gear Assembly (fig. 104).** Disconnect the drag link at the Pitman arm. Remove the cap screw that secures the brake master cylinder shield to the master cylinder. Remove the three nuts and bolts that secure the steering gear assembly to the frame. Remove the steering gear assembly and master cylinder shield from the vehicle.

**i. Remove Clutch and Brake Levers (fig. 103).** Remove the cotter pin from the clutch and brake pedal shaft at the clutch end of the shaft. Remove the nut and bolt that secure the clutch pedal to the shaft. Remove the clutch pedal and Woodruff key from the shaft. Remove the clutch and brake pedal return springs leading from the pedals to the transmission support crossmember. Remove the two cap screws that secure the master cylinder tie bar to the brake master cylinder. Remove the clutch and brake pedal shaft with the brake pedal and the clutch release shaft from the frame as a unit.

**j. Remove Brake Master Cylinder (fig. 104).** Disconnect the hydraulic brake line leading to the flexible connection at the forward



RA PD 329141

Figure 105 — Frame Assembly

## BODY AND FRAME

end of the frame. Remove the lock plate that secures the flexible hose to the frame. Disconnect the hydraulic brake line leading to the rear wheels at the master cylinder. Remove the two bolts that secure the master cylinder to the frame and remove the master cylinder. Disconnect the hydraulic brake line at the flexible connection on the center crossmember. Remove the lock plate that secures the flexible hose to the center crossmember.

**k. Remove Front Axle (fig. 35).** Remove the cotter pin from the upper end of the two front shock absorbers. Pull the shock absorbers off the brackets on the frame. Remove the two spring shackle bushings from the forward end of each front spring and remove the spring shackles. Remove the shackle bolt that secures the rear ends of the front springs to the frame. Remove the front axle from the frame.

**l. Remove Rear Axle (fig. 77).** Remove the cotter pin from the upper ends of the two rear shock absorbers and pull the shock absorbers off the brackets on the frame. Remove the two spring shackle bushings at the rear end of the frame from each spring. Remove the shackle bolts that secure the forward end of the rear springs to the frame. Remove the rear axle from the frame.

**m. Remove Ground Straps (fig. 104).** Remove the two radiator ground straps at the front crossmember of the frame. Remove the ground strap at the transmission support crossmember. Remove the battery ground cable at the front crossmember.

## 45. INSPECTION AND REPAIR.

### a. Inspection.

(1) **CHECK FRAME ALINEMENT (fig. 105).** The extent of misalignment of the frame can be determined by taking measurements at the various points as indicated in figure 105. Measure the distance from A to D and from B to C. The distance between these two points should not vary more than  $\frac{1}{8}$  inch. Measure the distance from C to F and D to E. The distance between these two points should not vary more than  $\frac{1}{8}$  inch. Measure the distance from E to H and F to G. The distance between these two points should not vary more than  $\frac{1}{8}$  inch. Measure the distance from H to J and G to K. The distance between these two points should not vary more than  $\frac{1}{8}$  inch. If the frame is found to be out of alinement, in most cases it can be corrected by straightening or replacing the damaged frame members or sections.

(2) **INSPECT FRAME FOR LOOSE RIVETS.** Replace any rivets that are loose or missing. Replace the battery support bracket if bent.

**ORDNANCE MAINTENANCE — POWER TRAIN, BODY, AND FRAME FOR ¼-TON 4 x 4 TRUCK  
(WILLYS-OVERLAND MODEL MB AND FORD MODEL GPW)****46. INSTALLATION.**

a. **Install Ground Straps (fig. 104).** Install the two radiator ground straps at the front crossmember of the frame. Install the ground strap at the transmission support crossmember. Install the battery ground cable at the front crossmember.

b. **Install Rear Axle (fig. 77).** Place the rear axle in position under the frame. Install the rear spring forward shackle bolts with the grease fittings facing outward. Install the two castellated nuts and cotter pins that secure the shackle bolts. Install the rear spring rear shackles with the shackle ends facing outward. Install the two shackle bushings to each spring shackle. Install the shock absorbers to the brackets at each side of the frame.

c. **Install Front Axle (fig. 35).** Place the front axle in position under the frame. Install the two front spring rear shackle bolts with the grease fittings facing outward. Install the two castellated nuts and cotter pins that secure the shackle bolts. Install the spring shackle at the forward end of the frame with the shackle ends facing outward. Install the two spring shackle bushings to each spring shackle. Install the shock absorbers to the brackets at each side of the frame.

d. **Install Brake Master Cylinder (fig. 104).** Install the lock plate that secures the hydraulic brake flexible hose to the center crossmember of the frame. Connect the hydraulic brake line at the flexible connection on the center crossmember. Install the two bolts that secure the hydraulic brake master cylinder to the side of the frame. Install the brake line leading from the rear wheels to the brake master cylinder. Install the lock plate that secures the brake flexible hose at the bracket on the frame. Install the brake line leading from the flexible hose to the master cylinder.

e. **Install Clutch and Brake Pedals (fig. 103).** Install the clutch and brake shaft with brake pedal and clutch release shaft onto the frame. Install the two cap screws that secure the master cylinder tie bar to the master cylinder. Insert the brake pedal rod in the master cylinder. Install the clutch and brake return springs leading from the clutch and brake pedals to the transmission support crossmember. Install the Woodruff key on the clutch and brake pedal shaft. Slide the clutch pedal on the clutch shaft. Install the lock bolt that secures the clutch pedal to the shaft and install the cotter pin.

f. **Install Steering Assembly and Bleed Brakes (fig. 104).** Place the steering assembly in position on the frame. Install the three nuts and bolts that secure the steering assembly to the frame. Connect

## BODY AND FRAME

the drag link at the Pitman arm. Bleed the hydraulic brake system. (Refer to TM 9-803.)

**g. Install Engine in Vehicle (fig. 104).** Install a suitable lifting sling on the engine and place the engine in position on the frame. Move the rear of the engine slightly to the right-hand side so as to allow the ball joint on the transfer case to enter in the clutch release shaft. Install the two nuts and bolts that secure the engine mounts to the engine support brackets on each side of the frame. Install the two ground straps leading from the engine support brackets to the engine. Install the two nuts that secure the transmission to the transmission support crossmember. Install the ground strap leading from the transmission to the transmission support crossmember. Install the clevis pin that secures the clutch control cable to the clutch release shaft. Install the engine stay cable to the transmission support crossmember.

**h. Install Front and Rear Bumpers (fig. 104).** Place the front bumper in position on the frame. Install the four nuts and bolts that secure the bumper to the ends of the frame. Place the two bumperettes in position on the rear crossmember of the frame and install the eight cap screws that secure the bumperettes to the rear crossmember of the frame.

**i. Install Propeller Shafts (fig. 100).** Place the front propeller shaft in the universal joint flange at the transfer case. Install the two U-bolts that secure the propeller shaft to the transfer case. Place the rear propeller shaft yoke flange in position on the transfer case. Install the four nuts that secure the propeller shaft to the transfer case.

**j. Install Exhaust Pipe and Transmission Shield (fig. 100).** Install the two nuts that secure the exhaust pipe to the exhaust manifold. Place the transmission shield in position under the vehicle. Install the five bolts that secure the transmission shield to the transmission. Install the clamp that secures the exhaust pipe to the shield.

**k. Install Radiator and Radiator Guard (fig. 103).** Place the insulators on the radiator brackets on the frame. Place the radiator in position in the brackets on the frame. Install the flat washers, ground straps, and flat washers on the two radiator studs. Install the nuts that secure the radiator to the frame. Install the upper and lower radiator hose connections. Install the radiator guard in the bracket in front of the radiator. Install the three nuts and bolts that secure the guard to the frame.

**l. Install Fenders and Body (fig. 102).** Place the fenders in position on the vehicle. Install the seven cap screws that secure each

**ORDNANCE MAINTENANCE — POWER TRAIN, BODY, AND FRAME FOR ¼-TON 4x4 TRUCK  
(WILLYS-OVERLAND MODEL MB AND FORD MODEL GPW)**

fender to the radiator guard and to the frame. Install the body on the chassis (par. 41).

m. **Install Battery** (fig. 101). Place the battery in the battery rack. Install the hold-down bracket on the battery. Install the two wing nuts that secure the hold-down bracket. Connect the negative and positive cables to the battery.

n. **Lubricate.** Lubricate the chassis of the vehicle with specified lubricants. Fill the radiator to proper level with coolant.

---

**Section V**

**FITS AND TOLERANCES**

**47. FITS AND TOLERANCES.**

<b>Fit Location and Name</b>	<b>Manufacturer's Fit Tolerance</b>	<b>Fit Wear Limit</b>	<b>Type of Fit</b>
<b>a. Front Springs.</b>			
Spring bushing and shackle bolt	—	0.010 in.	Running
Torque reaction spring and shackle bolt	—	0.010 in.	Running
Torque reaction spring shackle inner bushing and lower shackle bolt	—	0.010 in.	Running
Torque reaction spring shackle outer bushing and lower shackle bolt	—	0.010 in.	Running
<b>b. Rear Springs.</b>			
Rear spring bushing and shackle bolt	—	0.010 in.	Running
<b>c. Steering Gear.</b>			
Sector shaft bushing and sector shaft	—	0.001 in.	Running
<b>d. Monroe Shock Absorber.</b>			
Piston and pressure tube	0.002 in.	0.004 in.	Running

CHAPTER 4  
SPECIAL TOOLS

48. PURPOSE.

- a. The special tools required for maintenance and repair of the ¼-ton 4 x 4 Truck are listed in SNL G-27.
- b. The following list, extracted from SNL G-27, contains those special tools required to perform the operations described in this manual. The list is supplied for identification purposes only; it is not to be used as a basis for requisition.

49. LIST OF SPECIAL TOOLS.

a. Special Tools for Power Train.

Name	Federal Stock Number	Mfr's Number	Figure Number
Gage, drive pinion setting (set)	41-G-176	KM-J-589-S	67 and 106
Locator, idle gear thrust washer	41-L-1570	KM-J-1758	106
Remover, drive pinion flange and side bearing	41-R-2378-30	KM-J-872-S	49 and 106
Remover, drive pinion oil seal	41-R-2378-40	KM-J-1742	106
Remover, front axle outer oil retainer	41-R-2384-38	KM-J-943	55-80
Remover, mainshaft front cone, transmission	41-R-2368-200	KM-J-1749	106
Replacer, axle shaft, front and rear oil seal	41-R-2391-20	KM-J-1753	56 and 106
Replacer, differential side bearing cone	41-R-2391-65	KM-J-1763	68 and 106
Tool, oil seal assembly shifter shaft (set)	41-T-3280	KM-J-1757	106
Tool, universal joint, assembly and disassembly	41-T-3379	KM-J-881-A	—
Wrench, wheel bearing nut	41-W-3825-200	GP-17033	—

b. Special Tools for Shock Absorbers (Monroe).

Compressor, shock absorber grommet	41-C-2554-400	MAS-1148	—
Filler cup, Monroe shock absorber	41-F-2985-200	—	106
Remover, base valve	41-R-2373-340	—	106
Remover, rod guide and seal assembly	41-R-2373-115	—	106
Replacer, pressure tube	41-R-2399-350	—	106
Spanner wrench, special piston rod guide and seal assembly	41-W-3336-745	—	88 and 106
Thimble, piston rod	41-T-1657	—	106



	Federal Stock No.
A—REMOVER, DRIVE PINION OIL SEAL .....	41-R-2378-40
B—REPLACER, AXLE SHAFT FRONT AND REAR OIL SEAL .....	41-R-2391-20
C—REPLACER, DIFFERENTIAL SIDE BEARING CONE .....	41-R-2391-65
D—TOOL, OIL SEAL ASSEMBLY, TRANSFER CASE SHIFTER SHAFT SET .....	41-T-3280
E—REMOVER, MAINSHAFT FRONT CONE .....	41-R-2368-200
F—LOCATOR, IDLER GEAR THRUST WASHER .....	41-L-1570
G—REPLACER, PRESSURE TUBE .....	41-R-2399-350
H—REMOVER, DRIVE PINION FLANGE AND DIFFERENTIAL SIDE BEARING .....	41-R-2378-30
J—REMOVER, FRONT AXLE OUTER OIL RETAINER .....	41-R-2384-38
K—GAGE, DRIVE PINION SETTING (SET) .....	41-G-176
L—REMOVER, ROD GUIDE AND SEAL ASSEMBLY .....	41-W-2373-115
M—SPANNER WRENCH, SPECIAL PISTON ROD GUIDE AND SEAL ASSEMBLY .....	41-W-3336-745
N—THIMBLE, PISTON ROD .....	41-T-1657
O—FILLER CUP, SHOCK ABSORBER .....	41-F-2985-200
P—REMOVER, PRESSURE VALVE .....	41-R-2373-340

RA PD 329207- B

**Legend for Figure 106 — Special Tools**

**ORDNANCE MAINTENANCE — POWER TRAIN, BODY, AND FRAME FOR ¼-TON 4 x 4 TRUCK  
(WILLYS-OVERLAND MODEL MB AND FORD MODEL GPW)**

**REFERENCES**

**PUBLICATIONS INDEXES.**

The following publications indexes should be consulted frequently for latest changes or revisions of references given in this section and for new publications relating to materiel covered in this manual:

- a. Introduction to Ordnance Catalog (explaining SNL system) ..... ASF Cat.  
ORD 1 IOC
- b. Ordnance Publications for Supply Index (index to SNL's) ..... ASF Cat.  
ORD 2 OPSI
- c. Index to Ordnance Publications (listing FM's, TM's, TC's, and TB's of interest to ordnance personnel, OPSR, MWO's, BSD, S of SR's, OSSC's, and OFSB's; and includes Alphabetical List of Major Items with Publications Pertaining Thereto) ..... OFSB 1-1
- d. List of Publications for Training (listing MR's, MTP's, T/BA's, T/A's, FM's, TM's, and TR's concerning training) ..... FM 21-6
- e. List of Training Films, Film Strips, and Film Bulletins (listing TF's, FS's, and FB's by serial number and subject) ..... FM 21-7
- f. Military Training Aids (listing Graphic Training Aids, Models, Devices, and Displays) ..... FM 21-8

**STANDARD NOMENCLATURE LISTS.**

- Cleaning, preserving and lubricating materials; recoil fluids; special oils, and miscellaneous related items ..... SNL K-1
- Ordnance maintenance sets ..... SNL N-21
- Soldering, brazing and welding materials, gases and related items ..... SNL K-2
- Tools, maintenance for repair of automotive vehicles ..... SNL G-27  
Volume 1
- Tool-sets, for ordnance service command automotive shops ..... SNL N-30
- Tool-sets, motor transport ..... SNL N-19
- Truck, ¼-ton, 4 x 4, command reconnaissance (Ford and Willys) ..... SNL G-503

## REFERENCES

## EXPLANATORY PUBLICATIONS.

**Fundamental Principles.**

Automotive brakes .....	TM 10-565
Automotive electricity .....	TM 10-580
Automotive power transmission units .....	TM 10-585
Basic maintenance manual .....	TM 38-250
Chassis, body, and trailer units .....	TM 10-560
Electrical fundamentals .....	TM 1-455
Military motor vehicles .....	AR 850-15
Motor vehicle inspections and preventive maintenance service .....	TM 9-2810
Precautions in handling gasoline .....	AR 850-20
Sheet metal work, body, fender, and radiator repairs .....	TM 10-450
Standard military motor vehicles .....	TM 9-2800
The body finisher, woodworker, upholsterer, painter, and glassworker .....	TM 10-455
The machinist .....	TM 10-445

**Maintenance and Repair.**

Cleaning, preserving, lubricating and welding materials and similar items issued by the Ordnance Department .....	TM 9-850
Cold weather lubrication and service of combat vehicles and automotive materiel .....	OFSB 6-11
Maintenance and care of pneumatic tires and rubber treads .....	TM 31-200
Ordnance Maintenance: Electric equipment (Auto-Lite) .....	TM 9-1825B
Ordnance Maintenance: Engine and engine accessories for ¼-ton 4 x 4 truck (Ford and Willys) .....	TM 9-1803A
Ordnance Maintenance: Hydraulic brake system (Wagner) .....	TM 9-1827C
Ordnance Maintenance: Speedometers and tachometers (Stewart-Warner) .....	TM 9-1829A

**Operator's Manual.**

¼-ton 4 x 4 truck (Willys-Overland model MB and Ford model GPW) .....	TM 9-803
---	----------

## TM 9-1803B

### ORDNANCE MAINTENANCE — POWER TRAIN, BODY, AND FRAME FOR ¼-TON 4 x 4 TRUCK (WILLYS-OVERLAND MODEL MB AND FORD MODEL GPW)

#### Protection of Materiel.

Camouflage .....	FM 5-20
Chemical decontamination, materials and equip- ment .....	TM 3-220
Decontamination of armored force vehicles .....	FM 17-59
Defense against chemical attack .....	FM 21-40
Explosives and demolitions .....	FM 5-25

#### Storage and Shipment.

Ordnance storage and shipment chart, group G— Major items .....	OSSC-G
Registration of motor vehicles .....	AR 850-10
<i>Rules governing the loading of mechanized and motorized army equipment, also major caliber guns, for the United States Army and Navy, on open top equipment published by Operations and Maintenance Department of Association of American Railroads.</i>	
Storage of motor vehicle equipment .....	AR 850-18



ORDNANCE MAINTENANCE — POWER TRAIN, BODY, AND FRAME FOR ¼-TON 4 x 4 TRUCK  
(WILLYS-OVERLAND MODEL MB AND FORD MODEL GPW)

B — Cont'd	Page		Page
Brake plate		Clutch release fork	
installation		installation .....	23
front axle .....	81	removal .....	12
rear axle .....	95	Clutch shaft, installation to	
removal .....	89	transfer case .....	23
Brake springs, removal .....	11	Countershaft	
Bumpers		assembly .....	22
installation .....	135	inspection and repair .....	20
removal .....	131	Crossmember, support, transmission	
Bushings, countershaft, inspection		installation .....	23
and repair .....	21	removal .....	13
<b>C</b>		Cylinder, master brake	
Cable, clutch		disconnect .....	131
transfer case .....	25	installation .....	134
transmission .....	12	<b>D</b>	
Cable, engine stay		Data	
installation .....	24	axles	
removal .....	12	front .....	45
Cable, hand brake		rear .....	87
connect .....	127	Gabriel shock absorber .....	105
disconnect .....	125	propeller shafts and	
installation .....	24	universal joints .....	38
removal .....	12, 25	Monroe shock absorber .....	107
Cable, speedometer		special tools .....	137
connect .....	127	springs .....	99
disconnect .....	125	transfer case .....	25
installation		transmission .....	7
transfer case .....	38	Description	
transmission .....	24	axles	
Chassis lubrication .....	137	front .....	45
Cleaning		rear .....	86
front axle .....	60	power train .....	7
propeller shafts and universal		propeller (drive) shafts and	
joints .....	38	universal joints .....	38
rear axle .....	91	shock absorbers	
springs .....	101	Gabriel .....	104
steering gear assembly .....	112	Monroe .....	107
transmission parts .....	16	springs .....	99
Clutch		steering gear assembly .....	111
installation .....	38	transfer case .....	25
removal .....	131	transmission .....	7
Clutch pedal, installation .....	134	Differential assembly	
Clutch pedal pads		installation and adjustment	
installation .....	128	front axle .....	76
removal .....	125	rear axle .....	94
Clutch release bearing, assembly...	22		

INDEX

D -- Cont'd	Page		Page
Differential assembly — Cont'd		Exhaust pipe	
removal		installation .....	135
front axle .....	55	removal .....	131
rear axle .....	89		
replacement		<b>F</b>	
front axle .....	65	Fenders	
rear axle .....	92	installation .....	119, 135
Differential		removal .....	111, 129
disassembly .....	55	Floor plate, transmission .....	11
Differential cover		Frame	
installation		inspection and repair .....	128, 133
front axle .....	78	installation .....	134
rear axle .....	95	removal .....	128
Differential pinion gears		Frame alinement.....	133
removal from differential.....	89		
Disassembly		<b>G</b>	
drag link .....	120	Gear, countershaft	
front axle .....	49	assembly .....	21
Monroc shock absorber .....	109	disassembly .....	16
rear axle .....	89	inspection and repair .....	18
steering gear assembly .....	111	Gear, differential ring .....	76
transmission .....	15	Gear, first and reverse .....	18
Drag link		Gear, idle	
assembly, cleaning, inspection,		assembly .....	21
installation, and repair.....	122	inspection and repair .....	20
connect .....	119	Gear, idle reverse .....	16
disconnect .....	111	Gear, intermediate .....	35
removal and disassembly .....	120	Gear, main drive	
Drive flange		disassembly .....	16
installation .....	83	installation .....	23
Drive pinion		Gear, mainshaft	
removal		installation .....	38
front axle .....	58	removal .....	25
rear axle .....	89	Gear, steering (See Steering gear)	
Drive pinion assembly		Gears, installation	
replacement		front axle .....	75
front axle .....	65	rear axle .....	94
rear axle .....	92	Gears, axle shaft .....	89
Drive pinion bearing cap		Gears, differential pinion (See	
replacement .....	92	Differential pinion gears)	
Drum assembly		Gearshift housing	
rear axle .....	89	assembly .....	22
transfer case .....	25	removal .....	14
		Ground straps	
<b>E</b>		connect .....	127
Engine		disconnect .....	125
installation .....	135	installation .....	24, 134
removal .....	131	removal .....	12, 133
		Guide rail, shifter fork (See	
		Shifter fork guide rail)	

ORDNANCE MAINTENANCE — POWER TRAIN, BODY, AND FRAME FOR ¼-TON 4 x 4 TRUCK  
(WILLYS-OVERLAND MODEL MB AND FORD MODEL GPW)

H	Page		Page
Hood		Mainshaft	
installation .....	128	inspection and repair .....	18
removal .....	122	removal .....	16
Horn wire		Mainshaft assembly .....	21
installation .....	118	Mounting bolt, removal .....	25
replacement .....	115	Muffler	
Housing, inner and outer, bushing		connect .....	127
replacement .....	116	disconnect .....	125
Hub		<b>O</b>	
installation		Oil seal, replacement	
front axle .....	81	front axle .....	63
rear axle .....	97	rear axle .....	92
removal		Oil seal, spindle housing .....	79
rear axle .....	89	Output shaft, installation .....	31
Hydraulic brake hose		Output shaft bearing cap oil seal, replacement .....	30
installation .....	81	<b>P</b>	
Hydraulic brake line		Pedals, brake .....	134
disconnect .....	87	Pitman arm	
installation .....	97	disconnect .....	111
<b>I</b>		installation .....	118
Idle reverse gear (See Gear, idle reverse)		Pivot arm .....	70, 79
Inspection and repair		Pivot arm shaft .....	62
axles		Power train .....	7
front .....	60	Propeller shaft, front	
rear .....	91	disconnect .....	48
propeller shafts and universal joints .....	43	removal .....	39
steering gear assembly .....	112, 113	Propeller shaft, rear	
transmission .....	18	disconnect .....	25
<b>J</b>		removal .....	39
Knuckle, propeller shaft, removal		Propeller shafts	
front shaft .....	40	disconnect .....	87
rear shaft .....	41	installation .....	24, 38, 85, 97, 135
<b>K</b>		removal .....	12, 131
<b>L</b>		Propeller shafts and universal joints	
Lubrication		assembly .....	43
chassis .....	137	cleaning, inspection and repair..	43
clutch .....	24	data .....	39
front axle .....	86	description .....	39
rear axle .....	97	disassembly .....	40
<b>M</b>		installation .....	43
Main drive assembly .....	18	<b>R</b>	
Main drive gear assembly .....	21	Radiator	
Main drive gear bearing retainer....	14	installation .....	135
Main drive gear bearing rollers .....	20	removal .....	129

INDEX

<b>R — Cont'd</b>		<b>Page</b>			<b>Page</b>
Radiator guard			Shock absorbers		
installation .....	135		disconnect		
removal .....	129		front axle .....	48	
Radiator hose .....	12		rear axle .....	87	
Rear cover .....	25		installation		
Rear output shaft cap .....	35		front axle .....	85	
Ring gear			rear axle .....	97	
check run-out .....	78, 95		Snap rings (front propeller shaft)		
removal			removal from yoke .....	40	
front axle .....	58		Spider (front propeller shaft)		
rear axle .....	89		removal from yoke		
Ring gear, differential .....	94		front shaft .....	40	
Rivets in frame, loose .....	133		rear shaft .....	41	
Rzeppa universal joint			Spider (rear propeller shaft)		
disassembly .....	51		install in yoke flange .....	43	
replacement .....	65		Spindle		
			inspection and replacement .....	73	
<b>S</b>			installation .....	81	
Shaft, idle gear			Spindle arm		
inspection and repair .....	20		inspection and replacement of		
Shaft assembly			spindle bearing pin .....	71	
removal from housing .....	112		Spindle housing		
Shaft assembly, steering sector			adjustment and installation .....	79	
removal .....	112		removal .....	53	
Shift lever			Spindle housing bearing cap		
inspection and repair .....	21		inspection and replacement .....	71	
removal .....	11		Spring shackles		
Shift lever assembly			disconnect .....	48	
replacements .....	30		Spring U-bolts		
Shifter fork guide rail			disconnect		
removal .....	14		front axle .....	48	
Shifter forks			rear axle .....	87	
assembly .....	22		installation		
installation .....	31		front axle .....	83	
removal .....	14		rear axle .....	87	
Shock absorber, Gabriel			Springs		
cleaning and inspection .....	106		disconnect .....	87	
description and data .....	104		installation		
installation and adjustment .....	106		front .....	103	
removal .....	106		rear .....	97, 104	
Shock absorber, Monroe			removal		
adjustment .....	110		front .....	100	
assembly and disassembly .....	109		rear .....	101	
cleaning, inspection, and removal	109		Steering assembly		
description and data .....	107		installation .....	134	
fill with fluid .....	110		Steering column, installation .....	118	
installation .....	110		Steering column tube, removal .....	111	
			Steering gear, removal .....	111	

# TM 9-1803B

## ORDNANCE MAINTENANCE — POWER TRAIN, BODY, AND FRAME FOR ¼-TON 4x4 TRUCK (WILLYS-OVERLAND MODEL MB AND FORD MODEL GPW)

<b>S — Cont'd</b>		<b>Page</b>			<b>Page</b>
Steering gear assembly			disassembly .....		15
assembly .....	116		disconnect at clutch housing.....		12
cleaning and inspection .....	112		inspection and repair .....		18
description and disassembly .....	111		installation .....		23
removal .....	111, 131		removal .....		11, 13
repair .....	115		Transmission shield		
Steering gear worm, removal .....	113		installation .....		24, 135
Steering sector shaft assembly,			removal .....		11, 25
removal .....	112		Tubes, engine compartment .....		125
Steering wheel					
installation .....	119, 128		<b>U</b>		
removal .....	111, 125		Under drive shifter fork assembly..		30
Synchronizer, disassembly.....	16		Universal joints (See Propeller		
			shafts and universal joints,		
			Bendix universal joint, and		
			Tracta universal joint)		
<b>T</b>			<b>W</b>		
Tie rods			Washers, countershaft thrust .....		20
inspection and replacement of			Wheel alinement .....		86
end .....	70		Wheels		
installation .....	83		installation .....		85, 97
Tools, special .....	137		removal		
Torque, reaction spring bushing....	101		front axle .....		49
Tracta universal joint			rear axle .....		89
disassembly .....	53		Windshield		
replacement .....	70		installation .....		128
Transfer case			removal .....		122
assembly .....	30		Wires, engine compartment .....		125
cleaning, inspection, and repair....	27		Worm upper bearing cup .....		115
description and data .....	24				
installation .....	37		<b>Y</b>		
raising of .....	37		Yoke, front propeller shaft .....		40
removal and disassembly .....	25		Yoke flange, rear propeller shaft.....		41
Transfer case shield .....	38				
Transmission					
description and data .....	7				